

OPERATING MANUAL
Analog Programmable
DC POWER SUPPLIES
Agilent Technologies
Series 654xA, 655xA, 657xA



Agilent Technologies

CERTIFICATION

Agilent Technologies certifies that this product met its published specifications at time of shipment from the factory. Agilent Technologies further certifies that its calibration measurements are traceable to the United States National Bureau of Standards, to the extent allowed by the Bureau's calibration facility, and to the calibration facilities of other International Standards Organization members.

WARRANTY

This Agilent Technologies hardware product is warranted against defects in material and workmanship for a period of three years from date of delivery. Agilent Technologies software and firmware products, which are designated by Agilent Technologies for use with a hardware product and when properly installed on that hardware product, are warranted not to fail to execute their programming instructions due to defects in material and workmanship for a period of 90 days from date of delivery. During the warranty period Agilent Technologies will, at its option, either repair or replace products which prove to be defective. Agilent Technologies does not warrant that the operation of the software, firmware, or hardware shall be uninterrupted or error free.

For warranty service, with the exception of warranty options, this product must be returned to a service facility designated by Agilent Technologies. Customer shall prepay shipping charges by (and shall pay all duty and taxes) for products returned to Agilent Technologies for warranty service. Except for products returned to Customer from another country, Agilent Technologies shall pay for return of products to Customer.

Warranty services outside the country of initial purchase are included in Agilent Technologies' product price, only if Customer pays Agilent Technologies international prices (defined as destination local currency price, or U.S. or Geneva Export price).

If Agilent Technologies is unable, within a reasonable time to repair or replace any product to condition as warranted, the Customer shall be entitled to a refund of the purchase price upon return of the product to Agilent Technologies.

LIMITATION OF WARRANTY

The foregoing warranty shall not apply to defects resulting from improper or inadequate maintenance by the Customer, Customer-supplied software or interfacing, unauthorized modification or misuse, operation outside of the environmental specifications for the product, or improper site preparation and maintenance. **NO OTHER WARRANTY IS EXPRESSED OR IMPLIED. AGILENT TECHNOLOGIES SPECIFICALLY DISCLAIMS THE IMPLIED WARRANTIES OF MERCHANTABILITY AND FITNESS FOR A PARTICULAR PURPOSE.**

EXCLUSIVE REMEDIES

THE REMEDIES PROVIDED HEREIN ARE THE CUSTOMER'S SOLE AND EXCLUSIVE REMEDIES. AGILENT TECHNOLOGIES SHALL NOT BE LIABLE FOR ANY DIRECT, INDIRECT, SPECIAL, INCIDENTAL, OR CONSEQUENTIAL DAMAGES, WHETHER BASED ON CONTRACT, TORT, OR ANY OTHER LEGAL THEORY.

ASSISTANCE

The above statements apply only to the standard product warranty. Warranty options, extended support contracts, product maintenance agreements and customer assistance agreements are also available. Contact your nearest Agilent Technologies Sales and Service office for further information on Agilent Technologies' full line of Support Programs.

SAFETY SUMMARY

The following general safety precautions must be observed during all phases of operation of this instrument. Failure to comply with these precautions or with specific warnings elsewhere in this guide violates safety standards of design, manufacture, and intended use of the instrument. Agilent Technologies assumes no liability for the customer's failure to comply with these requirements.

GENERAL.

This product is a Safety Class 1 instrument (provided with a protective earth terminal). The protective features of this product may be impaired if it is used in a manner not specified in the operation instructions.

Any LEDs used in this product are Class 1 LEDs as per IEC 825-1.

This ISM device complies with Canadian ICES-001. Cet appareil ISM est conforme à la norme NMB-001 du Canada.

ENVIRONMENTAL CONDITIONS

All instruments are intended for indoor use in an installation category II, pollution degree 2 environment. They are designed to operate at a maximum relative humidity of 95% and at altitudes of up to 2000 meters. Refer to the specifications tables for the ac mains voltage requirements and ambient operating temperature range.

BEFORE APPLYING POWER.

Verify that the instrument is set to match the available line voltage.

GROUND THE INSTRUMENT.

To minimize shock hazard, the instrument chassis and cover must be connected to an electrical ground. The instrument must be connected to the ac power mains through a three-conductor power cable, with the third wire firmly connected to an electrical ground (safety ground) at the power outlet. Any interruption of the protective (grounding) conductor or disconnection of the protective earth terminal will cause a potential shock hazard that could result in personal injury. If the instrument is to be energized via an external autotransformer for voltage reduction, be certain that the autotransformer common terminal is connected to the neutral (earth pole) of the ac power lines (supply mains).

FUSES.

Only fuses with the required rated current, voltage and specified type (normal blow, time delay, etc.) should be used. Do not use repaired fuses or short-circuited fuseholders. To do so could cause a shock or fire hazard.

DO NOT OPERATE IN AN EXPLOSIVE ATMOSPHERE.

Do not operate the instrument in the presence of flammable gases or fumes.

KEEP AWAY FROM LIVE CIRCUITS.

Operating personnel must not remove instrument covers. Component replacement and internal adjustments must be made by qualified service personnel. Do not replace components with power cable connected. Under certain conditions, dangerous voltages may exist even with the power cable removed. To avoid injuries, always disconnect power, discharge circuits and remove external voltage sources before touching components.

DO NOT EXCEED INPUT RATINGS.

This instrument may be equipped with a line filter to reduce electromagnetic interference and must be connected to a properly grounded receptacle to minimize electric shock hazard. Operation at line voltages or frequencies in excess of those stated on the line rating label may cause leakage currents in excess of 5.0 mA peak.

SAFETY SYMBOLS.



The WARNING sign denotes a hazard. It calls attention to a procedure, practice, or the like, which, if not correctly performed or adhered to, could result in personal injury. Do not proceed beyond a WARNING sign until the indicated conditions are fully understood and met.





















The CAUTION sign denotes a hazard. It calls attention to an operating procedure, or the like, which, if not correctly performed or adhered to, could result in damage to or destruction of part or all of the product. Do not proceed beyond a CAUTION sign until the indicated conditions are fully understood and met.

DO NOT SUBSTITUTE PARTS OR MODIFY INSTRUMENT.

Because of the danger of introducing additional hazards, do not install substitute parts or perform any unauthorized modification to the instrument. Return the instrument to an Agilent Technologies Sales and Service Office for service and repair to ensure that safety features are maintained.

Instruments that appear damaged or defective should be made inoperative and secured against unintended operation until they can be repaired by qualified service personnel.

SAFETY SYMBOL DEFINITIONS

Symbol	Description	Symbol	Description
	Direct current		Terminal for Line conductor on permanently installed equipment
	Alternating current		Caution, risk of electric shock
	Both direct and alternating current		Caution, hot surface
	Three-phase alternating current		Caution (refer to accompanying documents)
	Earth (ground) terminal		In position of a bi-stable push control
	Protective earth (ground) terminal		Out position of a bi-stable push control
	Frame or chassis terminal		On (supply)
	Terminal for Neutral conductor on permanently installed equipment		Off (supply)
	Terminal is at earth potential (Used for measurement and control circuits designed to be operated with one terminal at earth potential.)		Standby (supply) Units with this symbol are not completely disconnected from ac mains when this switch is off. To completely disconnect the unit from ac mains, either disconnect the power cord or have a qualified electrician install an external switch.

Herstellerbescheinigung

Diese Information steht im Zusammenhang mit den Anforderungen der Maschinenläminformationsverordnung vom 18 Januar 1991.

* Schalldruckpegel $L_p < 70$ dB(A) * Am Arbeitsplatz * Normaler Betrieb * Nach EN 27779 (Typprüfung).

Manufacturer's Declaration

This statement is provided to comply with the requirements of the German Sound Emission Directive, from 18 January 1991.

* Sound Pressure $L_p < 70$ dB(A) * At Operator Position * Normal Operation * According to EN 27779 (Type Test).

Printing History

The edition and current revision of this manual are indicated below. Reprints of this manual containing minor corrections and updates may have the same printing date. Revised editions are identified by a new printing date. A revised edition incorporates all new or corrected material since the previous printing date. Changes to the manual occurring between revisions are covered by change sheets shipped with the manual. In some cases, the manual change applies only to specific instruments. Instructions provided on the change sheet will indicate if a particular change applies only to certain instruments.

© Copyright 1992, 1993 Agilent Technologies Inc.

Edition 1 April 1992

..... January 1993

..... October 1993

..... April 2000, July 2004

This document contains proprietary information protected by copyright. All rights are reserved. No part of this document may be photocopied, reproduced, or translated into another language without the prior consent of Agilent Technologies. The information contained in this document is subject to change without notice.



Manufacturer's Name and Address

Responsible Party

Agilent Technologies, Inc.
550 Clark Drive, Suite 101
Budd Lake, New Jersey 07828
USA

Alternate Manufacturing Site

Agilent Technologies (Malaysia) Sdn. Bhd
Malaysia Manufacturing
Bayan Lepas Free Industrial Zone, PH III
11900 Penang,
Malaysia

Declares under sole responsibility that the product as originally delivered

- Product Names**
 - a) Single Output 2,000 Watt System dc Power Supplies
 - b) Single Output 2,000 Watt Manually Controlled dc Power Supplies
 - c) Single Output 5,000 Watt System dc Power Supplies
 - d) Single Output 6,500 Watt System dc Power Supplies
- Model Numbers**
 - a) 6671A, 6672A 6673A, 6674A, 6675A
 - b) 6571A, 6572A 6573A, 6574A, 6575A
 - c) 6680A, 6681A, 6682A, 6683A, 6684A
 - d) 6690A, 6691A, 6692A
 - e) E4356A
- Product Options** This declaration covers all options and customized products based on the above products.

Complies with the essential requirements of the Low Voltage Directive 73/23/EEC and the EMC Directive 89/336/EEC (including 93/68/EEC) and carries the CE Marking accordingly.

EMC Information ISM Group 1 Class A Emissions

As detailed in Electromagnetic Compatibility (EMC), Certificate of Conformance Number CC/TCF/02/020 based on Technical Construction File (TCF) HPNJ2, dated June 4, 2002

Assessed by: Celestica Ltd, Appointed Competent Body
Westfields House, West Avenue
Kidsgrove, Stoke-on-Trent
Staffordshire, ST7 1TL
United Kingdom

Safety Information and Conforms to the following safety standards.

- IEC 61010-1:2001 / EN 61010-1:2001
- Canada: CSA C22.2 No. 1010.1:1992
- UL 61010B-1: 2003

This DoC applies to above-listed products placed on the EU market after:

January 1, 2004

Date

Bill Darcy/ Regulations Manager

For further information, please contact your local Agilent Technologies sales office, agent or distributor, or *Agilent Technologies Deutschland GmbH, Herrenberger Straße 130, D71034 Böblingen, Germany*



DECLARATION OF CONFORMITY

According to ISO/IEC Guide 22 and CEN/CENELEC EN 45014



Manufacturer's Name and Address

Responsible Party

Agilent Technologies, Inc.
550 Clark Drive, Suite 101
Budd Lake, New Jersey 07828
USA

Alternate Manufacturing Site

Agilent Technologies (Malaysia) Sdn. Bhd
Malaysia Manufacturing
Bayan Lepas Free Industrial Zone, PH III
11900 Penang,
Malaysia

Declares under sole responsibility that the product as originally delivered

- Product Names**
- a) Single Output 500 Watt System dc Power Supplies
 - b) Single Output 500 Watt Manually Controlled dc Power Supplies
 - c) Single Output 500 Watt System Solar Array Simulator

- Model Numbers**
- a) 6651A, 6652A 6653A, 6654A, 6655A
 - b) 6551A, 6552A 6553A, 6554A, 6555A
 - c) E4350B, E4351B

Product Options This declaration covers all options and customized products based on the above products.

Complies with the essential requirements of the Low Voltage Directive 73/23/EEC and the EMC Directive 89/336/EEC (including 93/68/EEC) and carries the CE Marking accordingly.

EMC Information ISM Group 1 Class A Emissions

As detailed in Electromagnetic Compatibility (EMC), Certificate of Conformance Number CC/TCF/00/074 based on Technical Construction File (TCF) HPNJ1, dated Oct. 27, 1997

Assessed by: Celestica Ltd, Appointed Competent Body
Westfields House, West Avenue
Kidsgrove, Stoke-on-Trent
Staffordshire, ST7 1TL
United Kingdom

Safety Information and Conforms to the following safety standards.

- IEC 61010-1:2001 / EN 61010-1:2001
- Canada: CSA C22.2 No. 1010.1:1992
- UL 61010B-1: 2003

This DoC applies to above-listed products placed on the EU market after:

January 1, 2004

Date

Bill Darcy/ Regulations Manager

For further information, please contact your local Agilent Technologies sales office, agent or distributor, or *Agilent Technologies Deutschland GmbH, Herrenberger Straße 130, D71034 Böblingen, Germany*



Manufacturer's Name and Address

Responsible Party

Agilent Technologies, Inc.
550 Clark Drive, Suite 101
Budd Lake, New Jersey 07828
USA

Alternate Manufacturing Site

Agilent Technologies (Malaysia) Sdn. Bhd
Malaysia Manufacturing
Bayan Lepas Free Industrial Zone, PH III
11900 Penang,
Malaysia

Declares under sole responsibility that the product as originally delivered

Product Names a) Single Output 200 Watt System dc Power Supplies
b) Single Output 200 Watt Manually Controlled dc Power Supplies

Model Numbers a) 6641A, 6642A 6643A, 6644A, 6645A
b) 6541A, 6552A 6543A, 6544A, 6545A

Product Options This declaration covers all options and customized products based on the above products.

Complies with the essential requirements of the Low Voltage Directive 73/23/EEC and the EMC Directive 89/336/EEC (including 93/68/EEC) and carries the CE Marking accordingly.

EMC Information ISM Group 1 Class A Emissions

As detailed in Electromagnetic Compatibility (EMC), Certificate of Conformance Number CC/TCF/00/074 based on Technical Construction File (TCF) HPNJ1, dated Oct. 27, 1997

Assessed by: Celestica Ltd, Appointed Competent Body
Westfields House, West Avenue
Kidsgrove, Stoke-on-Trent
Staffordshire, ST7 1TL
United Kingdom

Safety Information and Conforms to the following safety standards.

IEC 61010-1:2001 / EN 61010-1:2001
Canada: CSA C22.2 No. 1010.1:1992
UL 61010B-1: 2003

This DoC applies to above-listed products placed on the EU market after:

January 1, 2004

Date

Bill Darcy/ Regulations Manager

For further information, please contact your local Agilent Technologies sales office, agent or distributor, or *Agilent Technologies Deutschland GmbH, Herrenberger Straße 130, D71034 Böblingen, Germany*

Table of Contents

1. General Information	
Introduction.....	11
Safety Considerations.....	11
Instrument Identification	11
Options.....	11
Accessories.....	12
Description.....	12
Front Panel Programming	13
Analog Programming	13
Output Characteristic	13
Specifications and Supplemental Characteristics	13
2. Installation	
Inspection.....	27
Damage	27
Items Supplied.....	27
Location and Cooling.....	27
Bench Operation	27
Rack Mounting.....	27
Temperature Performance.....	28
Input Power Source.....	28
Series 654xA and 655xA Supplies.....	28
Series 657xA Supplies	28
3. Turn-On Checkout	
Introduction.....	31
Preliminary Checkout.....	31
Series 654xA and 655xA Supplies.....	31
Series 657xA Supplies	31
Power-On Checkout.....	32
Output Checkout	32
Shifted Keys	32
Backspace Key.....	32
Setting the Output Voltage.....	32
Setting the Output Current	32
Save/Recall Checkout	35
In Case of Trouble.....	35
Line Fuse.....	35
Series 654xA and 655xA Supplies.....	35
Series 657xA Supplies	36
Error Messages.....	36
Selftest Errors.....	37
Runtime Error Messages	38
4. User Connections and Considerations	
Rear Panel Connections	39
Output Connectors	39
Series 654xA and 655xA Supplies.....	39
Series 657xA Supplies	39
Analog Connector	39

Table of Contents (continued)

Wire Size Selection	41
Output Isolation	42
Load Considerations.....	43
Capacitive Loads.....	43
Inductive Loads.....	43
Multiple Loads	44
Local Voltage Sensing	44
Series 654xA and 655xA Supplies.....	44
Series 657xA Supplies	44
Remote Voltage Sensing	45
Setting Up Remote Sense Operation	45
Series 654xA and 655xA Supplies	45
Series 657xA Supplies	45
Connecting the Sense Leads.....	45
CV Regulation.....	45
Series 654xA and 655xA Supplies.....	45
Series 657xA Supplies	45
Output Rating	45
Output Noise	46
Stability.....	46
Series 657xA Network	46
Operating Considerations.....	47
Auto-Parallel Operation	47
Auto-Parallel Wiring.....	47
General Auto-Parallel.....	48
Series 654xA and 655XA Auto-Parallel Programming.....	48
Series Operation.....	49
External Voltage Control	49
Programming Series 654xA and 655xA Supplies	50
Programming Series 657xA Supplies.....	51
OVP Considerations.....	51
Remote Sensing.....	51
Battery Charging	51
Series 654xA and 655xA Load Capacitance	51
5. Front Panel Operation	
Introduction.....	53
Getting Acquainted	53
Programming the Output.....	56
Introduction.....	56
Establishing Initial Conditions	56
Programming Voltage	57
Programming Current.....	57
CV Mode vs. CC Mode.....	58
Programming Overvoltage Protection.....	58
Programming Overcurrent Protection	59
Unregulated Operation	60
Saving and Recalling Operating States	60
Normal Operation	60
Turn-On Operation.....	60

Table of Contents (continued)

A.	Calibration	
	Introduction	63
	Equipment	63
	General Procedure	63
	Parameters Calibrated	63
	Equipment Connections	64
	Performing the Calibration	64
	Entering the Calibration Values	64
	Saving the Calibration Constants	64
	Changing the Calibration Password	64
	Disabling the Calibration Mode	66
	Calibration Error Messages	66
B.	Line Voltage Conversion	
	Series 654xA and 655xA Power Supplies	67
	Series 657xA Power Supplies	68
	Index	69
	AGILENT Sales and Support Office	75

General Information

Introduction

This is the operating manual for your Agilent Series 654xA, 655xA, and 657xA power supplies. Unless otherwise stated, the information in this manual applies to all models in the series. These supplies are the analog-programmable counterparts of the Agilent Series 664xA, 665xA, and 667xA GPIB System power supplies.

Safety Considerations

This power supply is a Safety Class 1 instrument, which means it has a protective earth terminal. That terminal must be connected to earth ground through a power source equipped with a 3-wire ground receptacle. Refer to the Safety Summary page at the beginning of this manual for general safety information. Before installation or operation, check the power supply and review this manual for safety warnings and instructions. Safety warnings for specific procedures are located at appropriate places in the manual.

Instrument Identification

The power supply is identified by a unique two-part serial number, such as 3343A 00177. The first part, or prefix, is a number-letter combination that provides the following information:

- 3343** The year and week of manufacture or last significant design change. Add 1960 to the first two digits to determine the year. For example, 33=1993, 34=1994, etc. The last two digits specify the week of the year (43 = the 43rd week).
- A** The letter indicates the country of manufacture, where A = USA.

Options

List of Options

Option	Description	Used with Agilent Series		
		654xA	655xA	657xA
100	Input power 100 Vac, nominal	X	X	
120	Input power 120 Vac, nominal	X	X	
200	Input power 200 Vac, nominal			X
220	Input power 220 Vac, nominal	X	X	
230	Input power 230 Vac, nominal	X	X	
240	Input power 240 Vac, nominal	X	X	
831	Power cord, 12 AWG, UL listed, CSA certified, without plug			X
832	Power cord, 4 mm ² , harmonized, without plug			X
834	Power cord, 10 AWG, UL listed, CSA certified, without plug			X
842	Power cord, 4 mm ² , harmonized, with IEC 309 32A/220V plug			X
843	Power cord, 12 AWG, UL listed, CSA certified, with JIS C8303 25A/250V plug			X
844	Power cord, 10 AWG, UL listed, CSA certified, with NEMA L6-30P 30A/250V locking plug			X

List of Options (continued)

Option	Description	Used with Agilent Series		
908	Rack mount kit (Agilent 5062-3974)	X		
	Rack mount kit (Agilent 5062-3977)		X	X
909	Rack mount kit with handles (Agilent 5062-3975)	X		
	Rack mount kit with handles (Agilent 5062-3983)		X	X

Accessories

Agilent No.	Description
1494-0058	Heavy duty slide mount kit for Series 657xA
1494-0059	Standard slide mount kit for Series 655xA
1494-0060	Standard slide mount kit for Series 654xA

Description

These units form a family of unipolar, analog programmable power supplies organized as follows:

Family	Power	Models
Series 654xA	200 W	Agilent 6541A, 6542A, 6543A, 6544A, 6545A
Series 655xA	500 W	Agilent 6551A, 6552A, 6553A, 6554A, 6555A
Series 657xA	2000 W	Agilent 6571A, 6572A, 6573A, 6574A, 6575A

This family is similar in performance to the corresponding GPIB system power supplies.

Analog Family	Corresponding GPIB Family
Agilent 654xA	Agilent 664xA
Agilent 655xA	Agilent 665xA
Agilent 657xA	Agilent 667xA

Each power supply is programmable locally from the front panel or remotely via a rear-panel analog control port. Operational features include:

- Constant voltage (CV) or constant current (CC) output over the rated output range.
- Built-in overvoltage (OV), overcurrent (OC), and overtemperature (OT) protection.
- Automatic turn-on selftest.
- Pushbutton nonvolatile storage and recall of up to 5 operating states.
- Local or remote sensing of output voltage.
- Auto-parallel operation for increased total current.
- Series operation for increased total voltage.
- Analog input for remote programming of voltage and current.
- Voltage output for external monitoring of output current.
- User calibration from the front panel.

Front Panel Programming

The front panel has both rotary (RPG) and keypad controls for setting the output voltage and current. The panel display provides digital readouts of the output voltage and current. Other front panel controls permit:

Front Panel Programming

The front panel has both rotary (RPG) and keypad controls for setting the output voltage and current. The panel display provides digital readouts of the output voltage and current. Other front panel controls permit:

- Enabling or disabling the output.
- Setting the overvoltage protection (OVP) trip voltage.
- Enabling or disabling the overcurrent protection (OCP) feature.
- Saving and recalling operating states.
- Calibrating the power supply.

Analog Programming

The power supply has an analog port for remote programming. The output voltage and/or current of the power supply may be controlled by d-c programming voltages applied to this port. The port also provides a monitor output that supplies a d-c voltage proportional to the output current.

Output Characteristic

General

The power supply can operate in either CV (constant voltage) or CC (constant current) over its voltage and current ratings (see “Performance Specifications”). The operating locus is shown by the output Characteristic Curve in “Supplemental Characteristics”. The operating point is determined by the voltage setting (V_s), the current setting (I_s), and the load impedance. Two operating points are shown. Point 1 is defined by the load line cutting the operating locus in the constant-voltage region. This region defines the CV mode. Point 2 is defined by the load line cutting the operating locus in the constant-current region. This region defines the CC mode.

Downprogramming

The power supply can sink current for more rapid down programming in the CV mode. For Series 654xA and 655xA supplies, this capability is defined by the second quadrant area ($-I_s$) of the Output Characteristic Curve. These supplies can sink about 20% of their maximum rated positive output current. For Series 657xA power supplies, this is an uncharacterized current-sinking area that provides a limited downprogramming capability.

Specifications and Supplemental Characteristics

Table 1-1 lists the specifications and supplemental characteristics of the Series 654xA and 655xA power supplies. Table 1-2 lists the specifications and supplemental characteristics for the Series 657xA power supplies. Specifications are warranted over the specified temperature range. Supplemental characteristics are not warranted but are descriptions of performance determined either by design or type testing.

Table 1-1a. Performance Specifications for Series 654xA and 655xA (Note 1)

Parameter	Agilent Model Number and Parameter Value				
Specifications are warranted over the temperature range 0 to 55° C with a resistive load and the output connected for local sensing.					
Output Ratings					
Voltage:	6541A/6551A 0 - 8 V	6542A/6552A 0 - 20 V	6543A/6553A 0 - 35 V	6544A/6554A 0 - 60 V	6545A/6555A 0 - 120 V
Current:*	6541A 0 - 20 A	6542A 0 - 10 A	6543A 0 - 6 A	6544A 0 - 3.5 A	6545A 0 - 1.5 A
	6551A 0 - 50 A	6552A 0 - 25 A	6553A 0 - 15 A	6554A 0 - 9 A	6555A 0 - 4 A
*Derate the output current 1% per °C from 40° C to 55° C.					
Front Panel Programming Accuracy (@ 25° ± 5 °C)					
Voltage:)	6541A/6551A 0.06% +5 mV	6542A/6552A 0.06% +10 mV	6543A/6553A 0.06% +15 mV	6544A/6554A 0.06% +26 mV	6545A/6555A 0.06% +51 mV
Current:	6541A 0.14 % +26mA	6542A 0.14 % +13mA	6543A 0.14 % +7mA	6544A 0.14 % +4mA	6545A 0.14 % +2mA
	6551A 0.15 % +60mA	6552A 0.15 % +25mA	6553A 0.15 % +13mA	6554A 0.15 % +8mA	6555A 0.15 % +4mA
Ripple & Noise (from 20 Hz to 20 MHz with outputs ungrounded, or with either output terminal grounded)					
Constant Voltage (rms):	6541A/6551A 300 µV	6542A/6552A 300 µV	6543A/6553A 400 µV	6544A/6554A 500 µV	6545A/6555A 700 µV
Constant Voltage (p-p):	6541A/6551A 3 mV	6542A/6552A 3 mV	6543A/6553A 4 mV	6544A/6554A 5 mV	6545A/6555A 7 mV
Constant Current (rms):	6541A 10 mA	6542A 5 mA	6543A 3 mA	6544A 1.5 mA	6545A 1 mA
	6551A 25 mA	6552A 10 mA	6553A 5 mA	6554A 3 mA	6555A 2 mA
Readback Accuracy (with respect to actual output @ 25° C ± 5 °C)					
Voltage:	6541A/6551A 0.07% +6 mV	6542A/6552A 0.07% +15 mV	6543A/6553A 0.07% +25 mV	6544A/6554A 0.07% +40 mV	6545A/6555A 0.07% +80 mV
+Current	6541A 0.15% +26 mA	6542A 0.15% +13 mA	6543A 0.15% +6.7 mA	6544A 0.15% +4.1 mA	6545A 0.15% +1.7 mA
	6551A 0.15% +67 mA	6552A 0.15% +26 mA	6553A 0.15% +15 mA	6554A 0.15% +7 mA	6555A 0.15% +3 mA
-Current	6541A 0.35% +40 mA	6542A 0.35% +20 mA	6543A 0.35% +12 mA	6544A 0.35% +6.8 mA	6545A 0.35% +2.9 mA
	6551A 0.35% +100 mA	6552A 0.35% +44 mA	6553A 0.35% +24 mA	6554A 0.35% +15 mA	6555A 0.35% +7 mA
Load Regulation (change in output voltage or current for any load change within ratings)					
Voltage:	6541A/6551A 1 mV	6542A/6552A 2 mV	6543A/6553A 3 mV	6544A/6554A 4 mV	6545A/6555A 5 mV
Current:	6541A 1 mA	6542A 0.5 mA	6543A 0.25 mA	6544A 0.25 mA	6545A 0.25 mA
	6551A 2 mA	6552A 1 mA	6553A 0.5 mA	6554A 0.5 mA	6555A 0.5 mA
Line Regulation (change in output voltage or current for any line change within ratings)					
Voltage:	6541A/6551A 0.5 mV	6542A/6552A 0.5 mV	6543A/6553A 1 mV	6544A/6554A 1 mV	6545A/6555A 2 mV
Current:	6541A 1 mA	6542A 0.5 mA	6543A 0.25 mA	6544A 0.25 mA	6545A 0.25 mA
	6551A 2 mA	6552A 1 mA	6553A 0.75 mA	6554A 0.5 mA	6555A 0.5 mA

Table 1-1a. Performance Specifications for Series 654xA and 655xA (continued)

Parameter	Agilent Model Number and Parameter Value
Transient Response Time	< 100 μ s for the output voltage to recover to its previous level (within 0.1% of the rated voltage or 20 mV, whichever is greater) following any step change in load current up to 50% of the rated current.
AC Input Ratings (selectable via internal switching - see Appendix B)	
Nominal line voltage:	100, 120, 220, 240 Vac (-13%, +6 %) 230 Vac (-10%, +10%) (Note 2)
Frequency:	50/60 Hz
Output Terminal Isolation	\pm 240 Vdc (maximum, from chassis ground)
Notes 1: For Supplemental Characteristics, see Table 1-1b. 2: For 230Vac operation, unit is internally set to 240Vac	

Table 1-1b. Supplemental Characteristics for Series 654xA and 655xA (Note 1)

Parameter	Agilent Model Number and Parameter Value				
Output Programming Range (maximum programmable values)					
Voltage:	6541A/6551A 8.190 V	6542A/6552A 20.475 V	6543A/6553A 35.831 V	6544A/6554A 61.425 V	6545A/6555A 122.85 V
Overvoltage Protection:	6541A/6551A 8.8 V	6542A/6552A 22.0 V	6543A/6553A 38.5 V	6544A/6554A 66.0 V	6545A/6555A 132.0 V
Current:	6541A 20.475 A	6542A 10.237 A	6543A 6.142 A	6544A 3.583 A	6545A 1.535 A
	6551A 51.88 A	6552A 25.594 A	6553A 15.356 A	6554A 9.214 A	6555A 4.095 A
Average Resolution					
Voltage:	6541A/6551A 2 mV	6542A/6552A 5 mV	6543A/6553A 10 mV	6544A/6554A 15 mV	6545A/6555A 30 mV
Current:	6541A 6 mA	6542A 3 mA	6543A 2 mA	6544A 1 mA	6545A 0.5 mA
	6551A 15 mA	6552A 7 mA	6553A 4 mA	6554A 2.5 mA	6555A 1.25 mA
Overvoltage Protection:	6541A/6551A 13 mV	6542A/6552A 30 mV	6543A/6553A 54 mV	6544A/6554A 93 mV	6545A/6555A 190 mV
Accuracy					
Overvoltage Protection:	6541A/6551A 160 mV	6542A/6552A 400 mV	6543A/6553A 700 mV	6544A/6554A 1.2 V	6545A/6555A 2.4 V
Analog Programming (VP):*	6541A/6551A 0.26% +6 mV	6542A/6552A 0.26% +15 mV	6543A/6553A 0.26% +27 mV	6544A/6554A 0.26% +45 mV	6545A/6555A 0.26% +90 mV
Analog Programming (IP):*	6541A 7.6% +18 mA	6542A 7.6% +9.2 mA	6543A 1.5%+5.5 mA	6544A 1.5%+3.2 mA	6545A 1.5%+1.4 mA
	6551A 7% +75 mA	6552A 7% +31 mA	6553A 7% +16 mA	6554A 7% +8 mA	6555A 7% +5 mA
Current Monitor (+IM):*	6541A 7.6% +65 mA	6542A 7.6% +32 mA	6543A 1.6% +8.1 mA	6544A 1.6% +7.1 mA	6545A 1.6% +1.8 mA
	6551A 7% +730 mA	6552A 7% +400 mA	6553A 7% +120 mA	6554A 7% +80 mA	6555A 7% +75 mA
*Referenced to supply output					
Note 1: For Performance Specifications, see Table 1-1a.					

Table 1-1b. Supplemental Characteristics for Series 654xA and 655xA (continued)

Parameter	Agilent Model Number and Parameter Value				
Drift Temperature Stability (following a 30-minute warmup, change in output over 8 hours under constant line, load, and ambient temperature)					
Voltage:	6541A/6551A 0.02% +0.4 mV	6542A/6552A 0.02% +1 mV	6543A/6553A 0.02% +2 mV	6544A/6554A 0.02% +3 mV	6545A/6555A 0.02% +6 mV
Current:	6541A 0.02% +16 mA	6542A 0.02% +6 mA	6543A 0.02% +3 mA	6544A 0.02% +2 mA	6545A 0.02% +1mA
	6551A 0.02% +40 mA	6552A 0.02% +15 mA	6553A 0.02% +8 mA	6554A 0.02% +5 mA	6555A 0.02% + 2.5mA
Temperature Coefficients (change per °C)					
Voltage:	6541A/6551A 60ppm+0.1mV	6542A/6552A 60 ppm +0.2mV	6543A/6553A 60 ppm +0.3mV	6544A/6554A 60 ppm +0.5mV	6545A/6555A 60 ppm+1.1mV
Current:	6541A 95ppm+0.82mA	6542A 95ppm+0.41mA	6543A 95ppm+0.18mA	6544A 95ppm+0.12mA	6545A 95ppm+0.04mA
	6551A 90ppm+1.4mA	6552A 90ppm+0.7mA	6553A 90ppm+0.3mA	6554A 90ppm+0.2mA	6555A 90ppm+0.2mA
Voltage Readback:	6541A/6551A 60ppm+0.2mV	6542A/6552A 60ppm +0.5 mV	6543A/6553A 60ppm+0.75mV	6544A/6554A 60 ppm +1.3mV	6545A/6555A 60 ppm+2.6mV
+Current Readback:	6541A 95ppm+1.2mA	6542A 95ppm+0.62mA	6543A 95ppm+0.33mA	6544A 95ppm+0.20mA	6545A 95ppm+0.08mA
	6551A 90ppm+1.7mA	6552A 90ppm+0.9mA	6553A 90ppm+0.5mA	6554A 90ppm+0.3mA	6555A 90ppm+0.2mA
-Current Readback:	6541A 110ppm+1.2mA	6542A 110ppm+0.62mA	6543A 110ppm+0.33mA	6544A 110ppm+0.20mA	6545A 110ppm+0.08mA
	6551A 100ppm+1.7mA	6552A 100ppm+0.9mA	6553A 100ppm+0.5mA	6554A 100ppm+0.3mA	6555A 100ppm+0.2mA
Overvoltage Protection:	6541A/6551A 200ppm+1.6mV	6542A/6552A 200ppm+3.3mV	6543A/6553A 200ppm+5mV	6544A/6554A 200ppm+13mV	6545A/6555A 200ppm+24mV
Analog Programming (VP):	6541A/6551A 60 ppm +0.1mV	6542A/6552A 60ppm+0.25mV	6543A/6553A 60 ppm +0.4mV	6544A/6554A 60 ppm +0.7mV	6545A/6555A 60ppm+1.25mV
Analog Programming (IP):	6541A 90ppm+0.56mA	6542A 90ppm+0.28mA	6543A 90ppm+0.17mA	6544A 90ppm+0.1 mA	6545A 90ppm+0.04mA
	6551A 85ppm+1.4mA	6552A 85ppm+0.7mA	6553A 85ppm+0.3mA	6554A 85ppm+0.2mA	6555A 85ppm+0.15mA
Current Monitor (+IM):	6541A 75ppm+0.61mA	6542A 75ppm +0.3mA	6543A 75ppm+0.06mA	6544A 75ppm+0.06mA	6545A 75ppm+0.02mA
	6551A 80ppm+1.4mA	6552A 80ppm+0.7mA	6553A 80ppm+0.3mA	6554A 80ppm+0.2mA	6555A 80ppm+0.15mA
Maximum Input Power:	Series 654xA: 480 VA; 400 W; 60 W with no load Series 655xA: 1380 VA; 1100 W; 120 W with no load				
Maximum AC Line Current Ratings	Series 654xA		Series 655xA		
100 Vac nominal:	4.4 A rms		12 A rms		
120 Vac nominal:	3.8 A rms		10 A rms		
220 Vac nominal:	2.2 A rms		5.7 A rms		
230 Vac nominal:	2.1 A rms		5.5 A rms		
240 Vac nominal:	2.0 A rms		5.3 A rms		

Table 1-1b. Supplemental Characteristics for Series 654xA and 655xA (continued)

Parameter	Agilent Model Number and Parameter Value					
Maximum Reverse Bias Current:	With AC input power applied and the dc output reverse biased by an external dc source, the supply will continuously withstand without damage a current equal to its output current rating.					
Remote Sensing Capability	Up to 1/2 of rated output voltage. Subtract voltage drop in load leads from specified output voltage rating. Add 3 mV to spec (see Table 1-1a) for each 1-volt change in the + output lead due to load current changes.					
Voltage Drop Per Lead:						
Load Voltage:						
Load Regulation:	Add 3 mV to spec (see Table 1-1a) for each 1-volt change in the + output lead due to load current changes.					
Downprogrammer Current Capability (± 15%):						
	Agilent 6541 5.8 A	Agilent 6542 2.5 A	Agilent 6543 1.5 A	Agilent 6544 0.9 A	Agilent 6545 0.75 A	
	Agilent 6551 11.6 A	Agilent 6552 5 A	Agilent 6553 3 A	Agilent 6554 1.8 A	Agilent 6555 1.5 A	
Monotonicity:	Output is monotonic over entire rated voltage, current, and temperature range.					
Auto-Parallel Configuration:	Up to 3 identical models					
Analog Programming (IP & VP)	0 to -5 V 10 kΩ, nominal					
Input Signal:*						
Input Impedance: *Signal source must be isolated.						
Current Monitor Output:	0 to -5 V represents zero to full-scale current output.					
Savable States	5					
Nonvolatile Memory Locations:	5 (0 through 4)					
Nonvolatile Memory Write Cycles:	40,000, typical					
Recommended Calibration Interval:	1 year					
Safety Compliance	CSA 22.2 No.231, IEC 348, UL 1244 VDE 0411					
Complies with: Designed to comply with:						
RFI Suppression (complies with):	FTZ 1046/84, Level B					

Table 1-1b. Supplemental Characteristics for Series 654xA and 655xA (continued)

Parameter	Agilent Model Number and Parameter Value		
Dimensions			
Width:	Series 654xA 425.5 mm (16.75 in)		Series 655xA 425.5 mm (16.75 in)
Height:	88.1 mm (3.5 in)		132.6 mm (5.22 in)
Depth:	439 mm (17.3 in)		497.8 mm (19.6 in)
Weight			
Net:	Series 654xA 14.2 kg (31.4 lb)		Series 655xA 25 kg (54 lb)
Shipping:	16.3 kg (36 lb)		28 kg (61 lb)

Output Characteristic Curve:

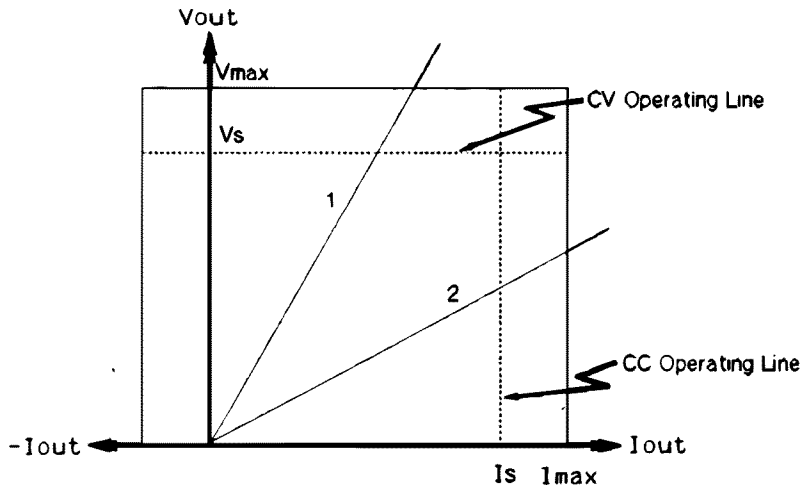

Maximum Rated Output

Agilent Model	Vout	Iout	-Iout
6541A	8 V	20 A	5 A
6542A	20 V	10 A	2 A
6543A	35 V	6 A	1.3 A
6544A	60 V	3.5 A	0.75 A
6545A	120 V	1.5 A	0.64 A
6551A	8 V	50 A	10 A
6552A	20 V	25 A	4.3 A
6553A	35 V	15 A	2.6 A
6554A	60 V	9 A	1.6 A
6555A	120 V	4 A	1.3 A

AGI-164L

Table 1-1b. Supplemental Characteristics for Series 654xA and 655xA (continued)

Parameter	Agilent Model Number and Parameter Value		
Output Impedance Agilent 654xA (Typical):			
		Agilent 6541A	Agilent 6542A
		Agilent 6543A	Agilent 6544A
	654XIMP.D.GAL		Agilent 6545A

Table 1-1b. Supplemental Characteristics for Series 654xA and 655xA (continued)

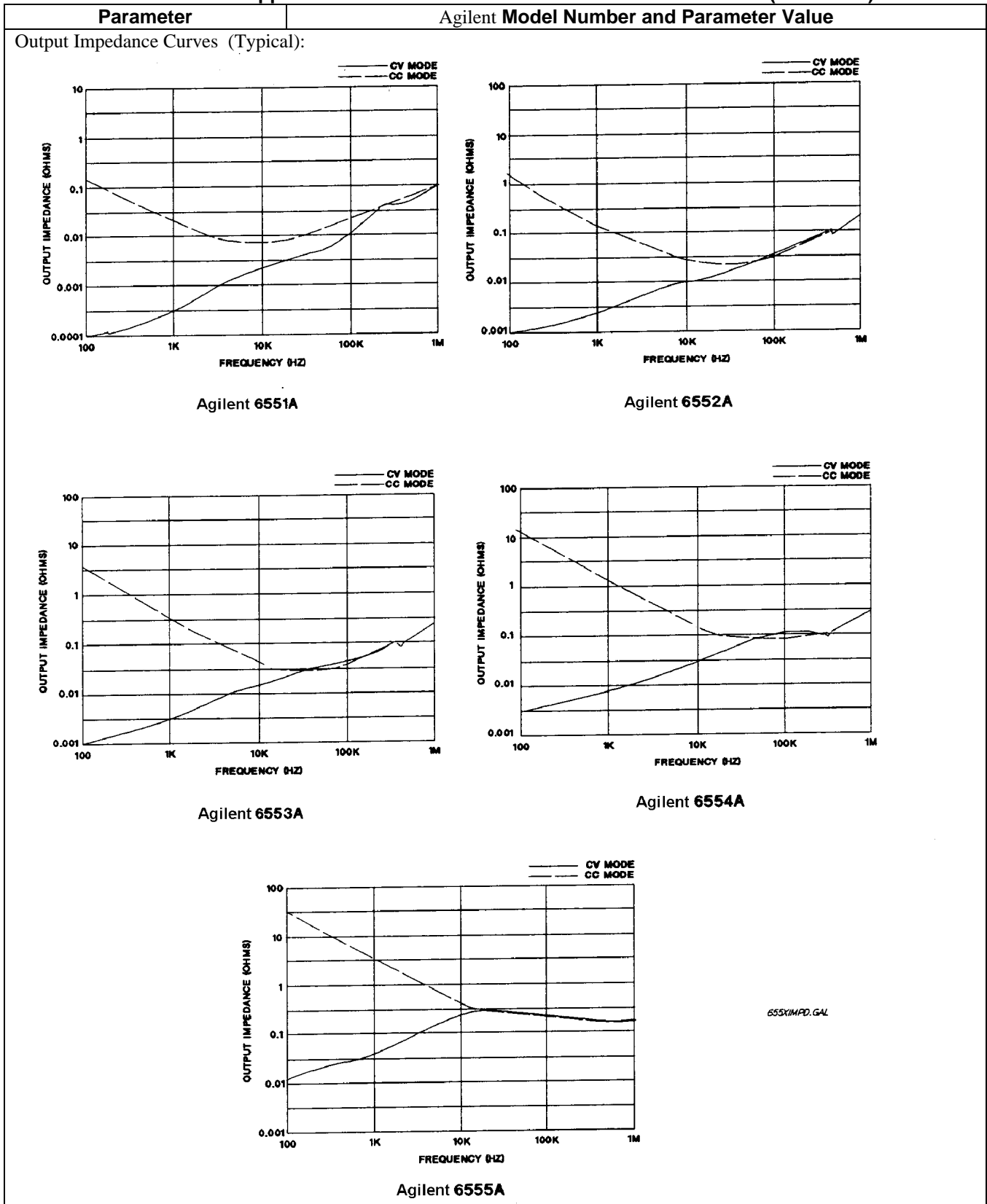

Table 1-2a. Performance Specifications for Series 657xA¹

Parameter	Agilent 6571A	Agilent 6572A	Agilent 6573A	Agilent 6574A	Agilent 6575A
Specifications are warranted over the temperature range 0 to 55° C with a resistive load and the output connected for local sensing.					
Output Ratings					
Voltage:	0 - 8 V	0 - 20 V	0- 35 V	0 - 60 V	0 - 120 V
Current:	0 - 220 A	0 - 100 A	0 - 60 A	0 - 35 A	0 - 18 A
Front Panel Programming Accuracy (@ 25° C ± 5 °C)					
Voltage:	0.04% +8 mV	0.04% +20 mV	0.04% +35 mV	0.04% +60 mV	0.04% +120 mV
Current:	0.11 % +125 mA	0.11 % +60 mA	0.11 % +40 mA	0.11 % +25 mA	0.11 % +12 mA
Ripple & Noise (from 20 Hz to 20 MHz with outputs ungrounded, or with either output terminal grounded)					
Constant Voltage(rms):	650 µV	750 µV	800 µV	1.25 mV	1.9 mV
Constant Voltage (p-p):	7 mV	9 mV	9 mV	11 mV	16 mV
Constant Current (rms):	200 mA	100 mA	40 mA	25 mA	12 mA
Readback Accuracy (with respect to actual output @ 25° C ± 5 °C)					
Voltage:	0.05% +12 mV	0.05% +30 mV	0.05% +50 mV	0.05% +90 mV	0.05% +180 mV
Current	0.1% +150 mA	0.1% +100 mA	0.1% +60 mA	0.1% +35 mA	0.1% +18 mA
Load Regulation (change in output voltage or current for any load change within ratings)					
Voltage:	0.002%+300µV	0.002%+650µV	0.002%+1.2mV	0.002%+2mV	0.002%+4mV
Current:	0.005%+10 mA	0.005%+7 mA	0.005%+4 mA	0.005%+2 mA	0.005%+1 mA
Line Regulation (change in output voltage or current for any line change within ratings)					
Voltage:	0.002%+300µV	0.002%+650µV	0.002%+1.2mV	0.002%+2mV	0.002%+4mV
Current:	0.005%+10 mA	0.005%+7 mA	0.005%+4 mA	0.005%+2 mA	0.005%+1 mA
Transient Response Time	< 900 µS for the output voltage to recover to within 100 mV following any step change in load current from 100% to 50%, or 50% to 100% of the rated current.				
AC Input Ratings (selectable via internal switching - see Appendix B)					
Nominal line voltage	174-220 Vac				
200 Vac:	174-220 Vac				
(Below 185 Vac, derate output voltage linearly to:)	7.8 V	18.0 V	31.5 V	56.5 V	108 V
230 Vac:	191-250 Vac				
Frequency range:	47-63 Hz				
Output Terminal Isolation	±240 Vdc (maximum, from output signal ground)				
Note 1: For Supplemental Characteristics, see Table 1-2b.					

Table 1-2b. Supplemental Characteristics for Series 657xA (Note 1)

Parameter	Agilent 6571A	Agilent 6572A	Agilent 6573A	Agilent 6574A	Agilent 6575A
Output Programming Range (maximum programmable values)					
Voltage:	8.190 V	20.475 V	35.831 V	61.425 V	122.85 V
Overshoot Protection (OVP):	10.0 V	24.0 V	42.0 V	72.0 V	144.0 V
Current:	225.23 A	102.37 A	61.43 A	35.83 A	18.43 A
Average Resolution					
Voltage:	2 mV	5 mV	10 mV	15 mV	30 mV
Current:	55 mA	25 mA	15 mA	8.75 mA	4.5 mA
OV Protection:	15 mV	35 mV	65 mV	100 mV	215 mV
Accuracy (at calibration temperature ±5° C)*					
Overshoot Protection :	200 mV	500 mV	900 mV	1.15 V	3.0 V
Analog Programming (VP):			±0.3%		
Analog Programming (IP):			±7%		
Current Monitor (+IM):			±7%		
*Factory calibration temp =25°C					
Drift Temperature Stability (following a 30-minute warmup, change in output over 8 hours under constant line, load, and ambient temperature)					
Voltage:	0.02%+0.24mV	0.02% +0.6 mV	0.02% +1 mV	0.02% +1.8 mV	0.02% +3.6 mV
Current:	0.02% +69mA	0.02% +35mA	0.02% +20mA	0.02% +10 mA	0.02% +6mA
Temperature Coefficients (change / °C and 30-minute warmup)					
Voltage:	50ppm+0.04mV	50ppm +0.2 mV	50ppm+0.7mV	50ppm +1.2 mV	50 ppm+2.4 mV
Current:	75 ppm +25mA	75 ppm +12 mA	75 ppm +7 mA	75 ppm +4 mA	75 ppm +2 mA
Voltage Readback:	60 ppm +0.1mV	60 ppm +0.3mV	60 ppm +1 mV	60 ppm +1.2mV	60 ppm +3 mV
±Current Readback:	85 ppm +30 mA	85 ppm +15 mA	85 ppm +9 mA	85 ppm +5 mA	85 ppm +2.5mA
Overshoot Protection:	200ppm+1.8mV	200 ppm +5 mV	200 ppm+8mV	200 ppm+13mV	200 ppm+25mV
Analog Programming (VP):	60 ppm +0.1mV	60 ppm +0.3mV	60ppm+0.5mV	60 ppm +0.7mV	60 ppm +1.5mV
Analog Programming (±IP):	275ppm+26mA	275 ppm+14mA	275 ppm+9mA	275 ppm +5 mA	275 ppm +3 mA
Current Monitor (+IM):	50 ppm +3mA	50 ppm +2mA	50 ppm+1mA	50ppm+0.6mA	50ppm+0.3mA
Maximum Input Power	3800 VA; 2600 W, 100 W with no load				
Maximum AC Line Current Ratings					
200 Vac nominal:	19 A rms				
230 Vac nominal:	19 A rms				
Maximum Reverse Bias Current:	With AC input power applied and the dc output reverse biased by an external dc source, the supply will continuously withstand without damage a current equal to its output current rating.				
Remote Sensing Capability					
Voltage Drop Per Lead:	Up to 1/2 of rated output voltage.				
Load Voltage:	Subtract voltage drop in load leads from specified output voltage rating.				
Load Regulation:					
Degradation due to load lead drop in -output:	None				
Degradation due to load lead drop in + output:	$\Delta mV \text{ (regulation)} = 2V_{\text{drop}} (V_{\text{rating}})/(V_{\text{rating}} + 10V)$				
Note 1: For Performance Specifications, see Table 1-2a.					

Table 1-2b. Supplemental Characteristics for Series 657xA (continued)

Parameter	Agilent 6571A	Agilent 6572A	Agilent 6573A	Agilent 6574A	Agilent 6575A																					
Monotonicity:	Output is monotonic over entire rated voltage, current, and temperature range.																									
Auto-Parallel Configuration:	Up to 5 identical models.																									
Analog Programming (IP & VP)																										
Input Signal*																										
VP Input:**	0 to -4.72 V	0 to -4.24 V	0 to -4.25 V	0 to -4.24 V	0 to -3.97 V																					
+IP/-IP Differential	0 to +7.97V	0 to +6.81 V	0 to +6.81 V	0 to +7.01 V	0 to +6.34 V																					
Input:																										
Input Impedance																										
VP Input:	60 kΩ,																									
IP Input:	52 kΩ																									
*Signal source must be isolated. **Referenced to output signal common.																										
Current Monitor (IM)																										
Output Signal:*	-0.25 to +9.05V	-0.25 to +7.7 V	-0.25 to +7.7 V	-0.25 to +7.93V	-0.25 to +7.15V																					
Output Impedance:	490 Ω																									
*Corresponds to 0% to 100% output current.																										
Savable States																										
Nonvolatile Memory	5																									
Locations:	5 (0 through 4)																									
Nonvolatile Memory Write Cycles:	40,000, typical																									
Recommended Calibration Interval:																										
1 year																										
Safety Compliance																										
Complies with:	CSA 22.2 No.231 & IEC 348																									
Designed to comply with:	UL 1244 & VDE 0411																									
RFI Suppression (complies with):																										
FTZ 1046/84, Level B																										
Dimensions																										
Width:	425.5 mm (16.75 in)																									
Height:	132.6 mm (5.22 in)																									
Depth (w/safety cover):	640 mm (25.2 in)																									
Weight																										
Net:	27.7 kg (61 lb)																									
Shipping:	31.4 kg (69 lb)																									
Output Characteristic Curve:																										
<table border="1"> <thead> <tr> <th colspan="3">Maximum Rated Output</th> </tr> <tr> <th>Agilent Model</th> <th>Vout</th> <th>Iout</th> </tr> </thead> <tbody> <tr> <td>6571A</td> <td>8 V</td> <td>220 A</td> </tr> <tr> <td>6572A</td> <td>20 V</td> <td>100 A</td> </tr> <tr> <td>6573A</td> <td>35 V</td> <td>60 A</td> </tr> <tr> <td>6574A</td> <td>60 V</td> <td>35 A</td> </tr> <tr> <td>6575A</td> <td>120 V</td> <td>18 A</td> </tr> </tbody> </table>						Maximum Rated Output			Agilent Model	Vout	Iout	6571A	8 V	220 A	6572A	20 V	100 A	6573A	35 V	60 A	6574A	60 V	35 A	6575A	120 V	18 A
Maximum Rated Output																										
Agilent Model	Vout	Iout																								
6571A	8 V	220 A																								
6572A	20 V	100 A																								
6573A	35 V	60 A																								
6574A	60 V	35 A																								
6575A	120 V	18 A																								
OPCURVE 4 GAL																										

Table 1-2b. Supplemental Characteristics for Series 657xA (continued)

Parameter	Agilent 6571A	Agilent 6572A	Agilent 6573A	Agilent 6574A	Agilent 6575A
-----------	---------------	---------------	---------------	---------------	---------------

Output Impedance Curves Agilent 657xA (Typical):

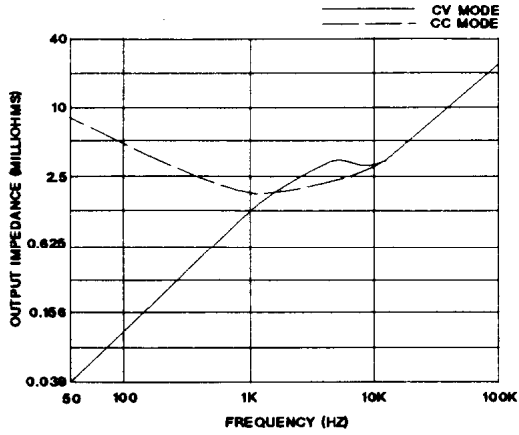

Agilent 6571A

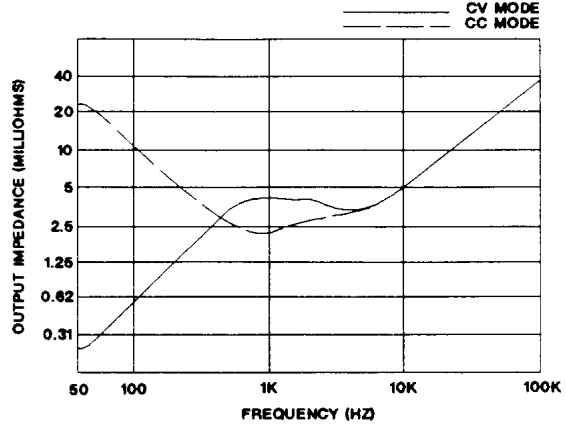

Agilent 6572A

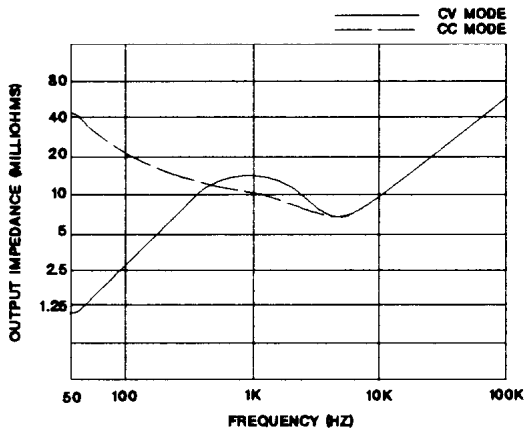

Agilent 6573A

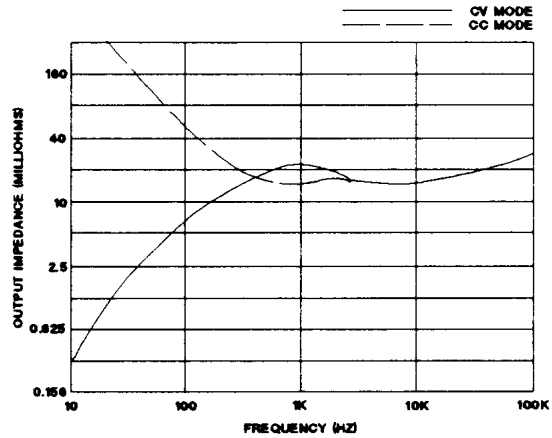

Agilent 6574A

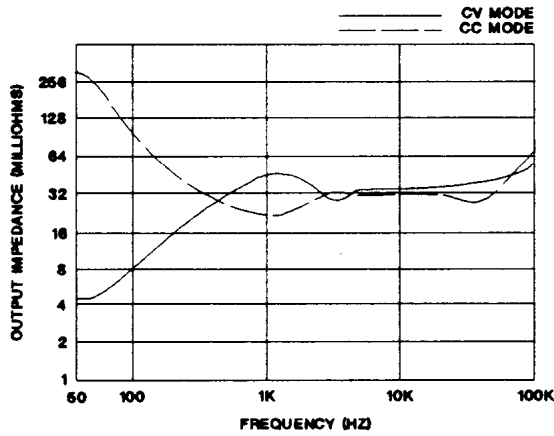

Agilent 6575A

657XIMP.D.GAL

Table 1-3. Replaceable Parts List

Description	Agilent Part No.
(Unless otherwise specified, parts apply to all models.)	
Collar, rotary output control	5040-1700
Foot, cabinet	5041-8801
Fuses, Series 654xA M6A 250V (for 100 Vac line voltage, reference designator F450) M5A 250V (for 120 Vac line voltage, reference designator F450) M3A 250V (for 220/230/240 Vac line voltage, reference designator F450) M15A 32V (for secondary rail bias, reference designator F402, F403) M5A 125V (for ac bias, reference designator F600, F601) M.125A 125V (for control circuits, reference designator F675, F700, 701) Fuseholder for Line (Littelfuse 345 101; UL, CSA, SEMKO, VDE approved; 6.3/15A, 250V)	2110-0056 2110-0010 2110-0003 2110-0697 2110-0699 2110-0671 2110-0927
Line Fuses, Series 655xA 100 Vac line voltage, 15 AM 120 Vac line voltage, 12 AM 220/230/240 Vac line voltage, 7 AM	2110-0054 2110-0249 2110-0614
Line Fuses, Series 657xA 200 Vac line voltage, 25 AM* 230 Vac line voltage, 25 AM* *This is an internal fuse not replaceable by the operator.	2110-0849 2110-0849
Knob, rotary output control	0370-1091
Lockwasher, output bus bar, 1/4 spring (Series 657xA)	3050-1690
Manual, service (Series 654xA and 655xA)	5959-3376
Manual, service (Series 657xA and 667xA)	5961-2583
Nut, output bus bar, hex 1/4-20x1/2 (Series 657xA)	2950-0084
Nut, power ground, hex w/lw 3/8x32	0590-0305
Power cord assembly (Series 657xA)	(See "Options")
Resistor, calibration	(See Appendix A)
Safety cover, ac input, w/strain relief connector & rubber boot (Series 657xA)	5040-1676
Safety cover, dc output (Series 654xA/655xA)	0360-2191
Safety cover, dc output (Series 657xA)	5040-1674
Screw, bus bar (Series 655xA)	0515-1085
Screw, carrying strap & safety cover, M5x0.8x10 mm	0515-1132
Screw, dc output safety cover (Series 654xA,655xA)	0515-1085
Screw, output bus bar, 1/4-20x1/2 (Series 657xA)	2940-0103
Screw, output sense terminal, M3x0.5x8 mm	0515-0104
Terminal, crimp, ac power cord, L or N terminal (Series 657xA)	0362-0681
Terminal, crimp, ac power cord, Gnd terminal (Series 657xA)	0362-0207

Installation

Inspection

Damage

When you receive your power supply, inspect it for any obvious damage that may have occurred during shipment. If there is damage, notify the shipping carrier and the nearest Agilent Sales and Support office immediately. Warranty information is printed in the front of this guide.

Save the shipping carton and packing materials in case the power supply must be returned to Agilent Technologies. If you return it for service, attach a tag identifying the model number and the owner. Also include a brief description of the problem.

Items Supplied

In addition to this manual, check that the following items are included with your power supply (see Table 1-4 for part numbers):

Power cord

Your power supply was shipped with a power cord for the type of outlet specified for your location. If the appropriate cord was not included, contact your nearest Agilent Sales and Support office (see end of this manual) to obtain the correct cord.



Your power supply cannot use a standard power cord. The power cords supplied by Agilent Technologies have heavier gauge wire.

Series 657xA Only

These power supplies also include output hardware (screws with nuts and lockwashers) for securing your load wires to the output bus bars (see Table 1-4).

Manual Change Page

If applicable, change sheets may be included with this manual. If there are change sheets, make the indicated corrections to this manual.

Location and Cooling

Bench Operation

The “Supplemental Characteristics” in Chapter 1 give the dimensions of your power supply. The cabinet has plastic feet that are shaped to ensure self-alignment when stacked with other Agilent System II cabinets. The feet may be removed for rack mounting. Your power supply must be installed in a location that allows sufficient space at the sides and rear of the cabinet for adequate air circulation. Minimum clearances are 1 inch (25 mm) along the sides. Do not block the fan exhaust at the rear of the supply.

Rack Mounting

The power supply can be mounted in a standard 19-inch rack panel or cabinet. Rack mounting kits are available as Option 908 or 909 (with handles). Installation instructions are included with each rack mounting kit. Instrument support rails are required for non-stationary installations. These are normally ordered with the cabinet and are not included with the rack mounting kits.

Temperature Performance

A variable-speed fan cools the supply by drawing air through the sides and exhausting it out the back. Using Agilent rack mount or slides will not impede the flow of air. The temperature performance is as follows:

Series 654xA/655xA Operates without loss of performance within the temperature range of 0 °C to 40 °C and with derated output from 40 °C to 55 °C.

Series 657xA Operates without loss of performance within the temperature range of 0 °C to 55 °C.

Input Power Source

Refer to the applicable paragraphs below for information on the input power source. *Do not apply power to the power supply until directed to do so in Chapter 3.*

CAUTION Check the line **Rating** label on the rear of your supply and verify that the voltage shown there corresponds to the nominal line voltage of your power source. If it does not, see Appendix B for instructions on changing the power supply's line voltage configuration.

Series 654xA and 655xA

You can operate your supply from a nominal 100 V, 120 V, 220 V, 230 V, or 240 V single-phase ac power source as indicated on the rear panel line Rating label. See "AC Input Ratings" in Table 1-1a for the voltage and frequency range for each type of power source. "Maximum AC Line Current Ratings" in Table 1-2a shows the required current load. The line fuse is located in a fuseholder on the rear panel (see Figure 2-1). The Line Fuse label on the rear panel shows the fuse value used in the power supply and Table 1-4 identifies the replacement fuse.

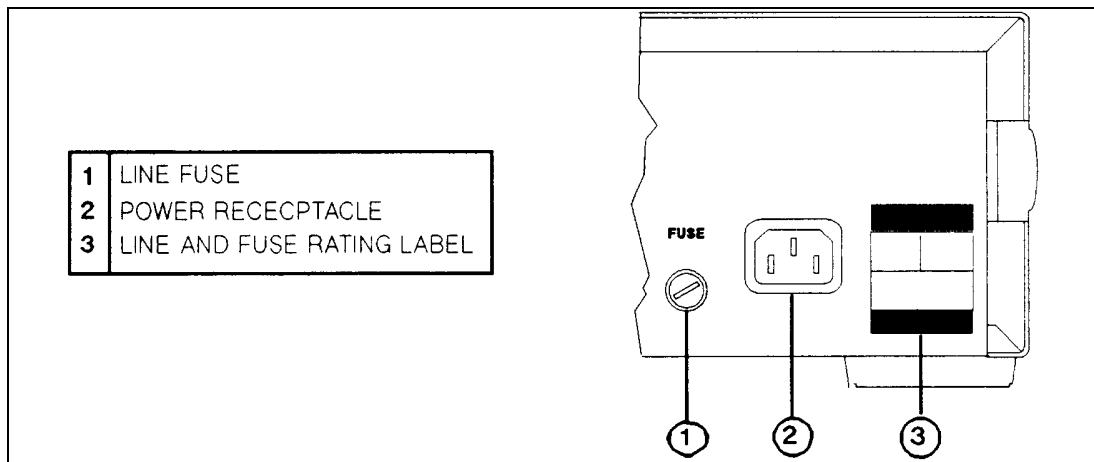

Figure 2-1. Series 654xA and 655xA Power Connection

Note The detachable power cord may be used as an emergency disconnecting device. Removing the power cord from the ac input connector will disconnect ac input power to the unit.

Series 657xA

Input Source and Line Fuse

You can operate your supply from a nominal 200 or 230 volt single-phase ac power source as indicated on the rear panel **Line Rating** label. See "AC Input Ratings" in Table 1-1b for the voltage and frequency range for each nominal power source. "Maximum AC Line Current Ratings" in Table 1-2b shows the required current load.

Note The power source must be a dedicated line with no other devices drawing current from it.

The line fuse is located inside the power supply. Table 1-4 identifies the replacement fuse. See "In Case of Trouble" in Chapter 3 for instructions on fuse replacement.

Installing the Power Cord

The power cord supplied with power supply may or may not include a power plug (see "Options" in Chapter 1) at one end of the cord. Terminating connections and a ground lug are attached to the other end of the cord.

WARNING

Installation of the power cord must be done by a qualified electrician and in accordance with local electrical codes.

See Figure 2-2 and proceed as follows:

1. If they are not already in place, position the strain relief connector (11), power safety cover (5), rubber boot (9), and connector nut (8) on the power cord (7).
2. Secure the ground connection wire (2) to the chassis earth ground stud.
3. Connect the neutral connection wire (1) to the N power input terminal.
4. Connect the line connection wire (3) to the L power input terminal. This line is fused inside the power supply
5. Position the safety cover (5) over the power input terminals and tighten the cover and strain relief connector screws (6 and 10).

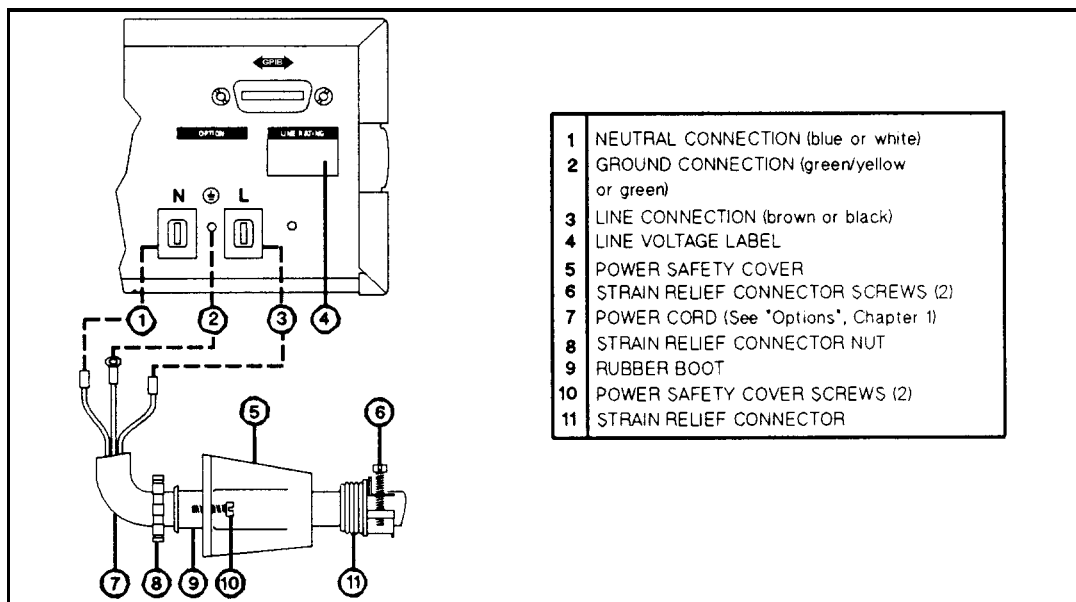

Figure 2-2. Series 657xA Power Cord Installation

Turn-On Checkout

Note This chapter provides a preliminary introduction to the power supply front panel. See Chapter 5 for more details.

Introduction

Successful tests in this chapter provide a high degree of confidence that the power supply is operating properly. For complete performance and/or verification tests, refer to the service manual (see Table 1-4 in Chapter 1).



Do not connect the power cord to the power source until told to do so.

Preliminary Checkout

Series 654xA and 655xA Power Supplies

If required, see Figure 2-1 in Chapter 2 and Figure 4-1 in Chapter 4 for parts locations.

- I. Make certain that the front panel switch is off.
- II. Examine the Line And Fuse Rating label (3, Figure 2-1).
 - A. Verify that the line voltage rating agrees with your power source. If it does not, see Appendix B.
 - B. Use a screwdriver to remove the line fuse from the fuseholder (1, Figure 2-1). Verify that the fuse is as specified on the label. Replace the fuse.
- III. Check that the SENSE switch (4, Figure 4-1) is set to Local.
- IV. Make sure that there is no load connected to the output (+) and (-) terminals (2, Figure 4-2).

Series 657xA Power Supplies

- I. Examine the Line Voltage label (4, Figure 2-2) and verify that the line voltage rating agrees with your power source. If it does not, see Appendix B.
- II. Remove the output safety cover (1, Figure 4-2).
- III. Examine the output sense terminals (4 and 5, Figure 4-2). They should be wired for local sensing as follows:
 - A. The **+LS** sense terminal wired to the **+S** terminal of the analog connector (2, Figure 4-2).
 - B. The **-LS** sense terminal wired to the **-S** terminal of the analog connector.
 - C. If the power supply is not wired for local sensing, make the above connections, using small-capacity wire (#22 is sufficient).
- IV. Make certain there is no load connected to the bus bars.

POWER-ON Checkout

1. Connect the power cord to the power source.
2. Turn the front panel power switch to ON (1).
3. Check that the power supply fan is on by placing your hand near the rear grill to feel the air flow. You may also be able to hear the fan operating.

The power supply undergoes a self-test when you turn it on. If the test is normal, the following sequence appears on the LCD:

1. A brief star-burst pattern 
2. PWR ON INIT for a few seconds (Series 657xA supplies only).
3. The display goes into the meter mode with the **Dis** annunciator on and all others off. “Meter mode” means that the **VOLTS** digits indicate the output voltage and the **AMPS** digits indicate the output current. These values will be at or near zero.

Note If the power supply detects an error during self-test, the display will show an error message. Go to “In Case of Trouble” at the end of this chapter.



4. Press  once. The **Dis** annunciator will go off and the **CV** annunciator will go on.

Output Checkout

Shifted Keys

Some of the front panel keys perform two functions, one labeled in black and the other in blue. You access the blue function by first pressing the blue  key, which is not labeled. When the **Shift** annunciator is on, you will know you have access to the key's shifted (blue) function.

Backspace Key

The  key is an erase key. If you make a mistake entering a number and have not yet entered it (have not pressed ), you can delete the number by pressing . You may delete as many numbers as you wish by repeatedly pressing this key.

Note The voltage and current values used in these tests are for a typical Agilent 655xA Series supply (the Agilent 6552A). Table 1-1a and Table 1-1b in Chapter 1 lists the ranges for other supplies. If needed, refer to those tables for the voltage and current ratings of your supply.

Setting The Output Voltage

Perform the steps in Table 3-1 to check the basic voltage functions with no load connected to the power supply. The **VOLTS** display will show various readings. Ignore the **AMPS** display.

Setting The Output Current

You must have a load on the power supply to generate a current output. For this purpose, you will connect a shorting wire across the output terminals of the supply.

CAUTION

Some power supplies have a high output current capacity. To prevent overheating or possible melting of the shorting wire, make sure it is of sufficient size to carry the supply's maximum output current (see Table 4-2 in Chapter 4 for the appropriate wire size).

Perform the steps in Table 3-2 to check the basic current functions with a short across the power supply output. The **AMPS** display will show various readings. Ignore the **VOLTS** display.

Table 3-1. Checking the Voltage Functions (Output Terminals Open)

If the Dis annunciator is on, turn it off by pressing Output on/off		
Press Voltage	VOLT 0.000	Displays default output voltage. CV annunciator is on. If CC annunciator remains on, increase the CC current setting by pressing Current 0 5
Press 2 0	VOLT 20	*Set voltage to supply's rated output.
Press Enter	20.000	Meter mode displays output voltage.
Press Voltage several times		**Voltage drops about 5 millivolts each time you press the key.
Press Voltage the same number of times		**Voltage increases about 5 millivolts each time you press the key.
Rotate the Voltage control first counterclockwise and then clockwise		Control operates similarly to the Voltage and Voltage keys. Turning the controls more quickly causes a more rapid change in voltage.
Press OV	OV 22.000	***Shows the default OVP trip voltage.
Press OV 1 5	OV 15	Program OV trip voltage to 15.
Press Enter		You have entered a trip voltage that is less than the output voltage. The output drops to near zero. The CV annunciator goes off and the Prot annunciator comes on.
Press Protect	OV	Indicates the overvoltage Protection circuit has tripped.
Press ←	Meter mode	
Press OV 2 1	OV 21	Raise the OV trip voltage up above the programmed output voltage.
Press ←		Enter the new trip voltage.
Press Shift Protect *****	20.000	You have cleared the OV protection fault. The Prot annunciator goes off, the CV annunciator comes on, and the full rated output is restored.

Table 3-1. Checking the Voltage Functions (continued)

*Maximum voltage values are for Agilent 6552A. See "Output Ratings" in "Performance Specifications" of Chapter 1 for your specific model.
 **Voltage increments are for Agilent 6552A. See "Average Resolution" in "Supplemental Characteristics" of Chapter 1 for your specific model.
 ***OV voltage is for Agilent 6552A. See "Output Programming Range" in "Supplemental Characteristics" of Chapter 1 for your specific model.
 **** **Shift** key is the unlabeled blue key.

Table 3-2. Checking the Current Functions (Output Terminals Shorted)

Turn off the power supply and connect a wire across the output (+) and (-) terminals. Use a wire of sufficient size to carry the maximum current of the supply (see "Performance Specifications" in Chapter 1).		
Turn on the supply	Meter mode	Essentially zero outputs with Dis annunciator on.
Press Voltage 1 0 5	VOLT 1.500	Set a minimum operating voltage to cause current to low.
Press Output on/off		Dis annunciator goes off, CC annunciator comes on, and AMPS display shows some current. If there is no current and CV annunciator remains on, increase the operating voltage setting.
Press ↑Current several times		*Current increases about 7 milliamperes each time you press the key.
Press ↓Current the same number of times		*Current decreases about 7 milliamperes each time you press the key.
Rotate the Current control first clockwise and then counterclockwise.		Control operates similarly to the ↑Current and ↓Current keys. Turning the controls more quickly causes a more rapid change in current.
Press OCP		You have enabled the overcurrent protection circuit, which tripped because of the output short. The CC annunciator goes off and the OCP and Prot annunciators come on. The output current is near zero.
Press Protect	OC	Indicates the overcurrent protection circuit has tripped. (see "Supplemental Characteristics" in Chapter 1).
Press ←	Meter mode	
Press Output on/off		Dis annunciator comes on.
Press OCP		You have disabled the overcurrent protection circuit. The OCP annunciator goes off.
Press Shift Protect *		You have cleared the OC protection circuit. The Prot annunciator goes off.

Table 3-2. Checking the Current Functions (continued)

Press Output on/off		Dis annunciator goes off and the CC annunciator comes on. AMPS shows some current.
Press Current 2 5 Enter	25.000	**AMPS increases to maximum output.
Press Output on/off		Dis annunciator comes on and AMPS reading drops to near zero.
Turn off the power supply and remove the short from the output terminals.		
* Current increments are for Agilent 6552A. See "Average Resolution" in "Supplemental Characteristics of Chapter 1 for your specific model.		
** Maximum current value is for Agilent 6552A. See "Output Ratings" in "Performance Specifications" of Chapter 1 for your specific model.		
**** Shift key is the unlabeled blue key.		

Save/Recall Checkout

The following steps check the power supply save and recall function keys.

- Make certain that the **Dis** annunciator is off. Then set the voltage output to 5 volts by pressing **Voltage** **5** **Enter**.
- Save this value to location 1 by pressing **Shift** **Recall** **1** **Enter**.
- Remove the output voltage by pressing **Recall** **0** **Enter**. This recalls the power supply values stored in location 0, which are the factory reset values (see Chapter 5 for more information).
- Press **Recall** **1** **Enter** and notice that the output voltage returns to 5.

In Case Of Trouble

Line Fuse

If the power supply appears "dead" with a blank display and the fan not running, first check your power source to be certain line voltage is being supplied to the power supply. If the power source is normal, the power supply line fuse may be defective. If this is the case, replace the fuse only once. If it fails again, investigate the reason for the failure. Proceed as follows:

Series 654xA and 655xA Supplies

The line fuse is located on the rear panel (1, Figure 2-1). Proceed as follows:

1. Turn off the front panel power switch.
2. Using a screwdriver, remove the fuse from the fuseholder. Replace it with one of the same type (see Table 1-4 in Chapter 1). **Do not use a "slow-blow" type fuse.**
3. Turn on the power supply and check the operation.

Series 657xA Supplies

WARNING

Hazardous voltage can remain inside the power supply even after it has been turned off. Fuse replacement should be done only by qualified electronics personnel.



The line fuse is located inside the power supply. To change it, proceed as follows:

- I. Turn off the front panel power switch and unplug the line cord from the power source.
- II. Remove the power supply dustcover as follows:
 - A. Remove the four screws securing the carrying straps and dustcover.
 - B. Spread the bottom rear of the dustcover and pull it back to disengage it from the front panel.
 - C. Slide the dustcover back far enough to expose the line fuse (1, Figure 3-1).
- III. Observe the input rail LED under the RFI shield (4, Figure B-3 in Appendix B). **If the LED is on, there is still hazardous voltage inside the supply.** Wait until the LED goes out (this may take several minutes) before proceeding.
- IV. Connect a dc voltmeter across test points TP1 and TP2 (see Figure B-3). It may be necessary to remove the RFI shield in order to reach these test points. (The shield is secured by four screws on each side.) When the voltmeter indicates 60 volts or less, it is safe to work inside the power supply.
- V. Replace the fuse with one of the same type (see Table 1-4 in Chapter 1). **Do not use a "slow-blow" type fuse.**
- VI. If you removed it in step b, be sure to replace the RFI shield.
- VII. Replace the dustcover.
- VIII. Connect the line cord to the power source.
- IX. Turn on the front panel power switch and check the operation.

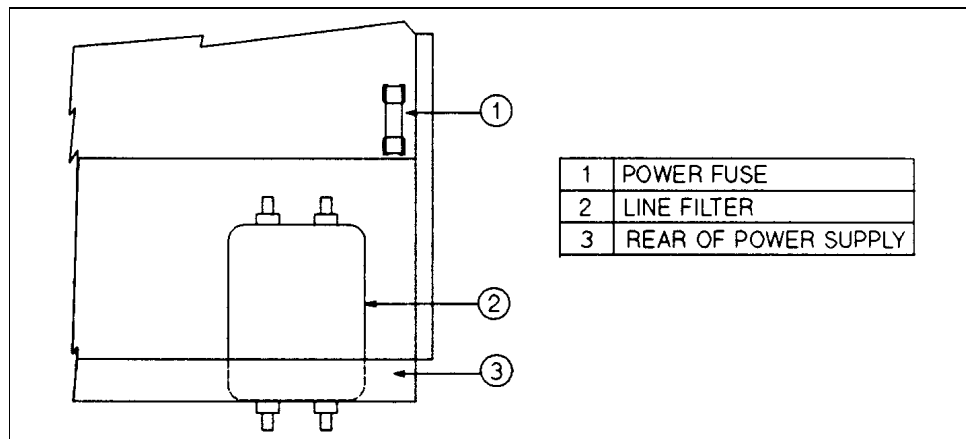

Figure 3-1. Series 657xA Line Fuse

Error Messages

Power supply failure may occur during power-on selftest or during operation. In either case the display may show an error message that indicates the reason for the failure.

Selftest Errors

When a selftest error occurs, it prevents all front panel operation. The display may show either a power-on error message or a checksum error message.

Power-on Error Messages. Power-on messages appear as:

En- - - - -

Where “n” is a number listed in Table 3-3. If this occurs, turn the power off and then back on to see if the error persists. It is possible to recover from the **EE CHKSUM** error (see "Checksum Errors"). If any other message persists, the power supply requires service.

Table 3-3. Power-on Selftest Errors

Error No	Display	Failed Test
E1	FP RAM	Front Panel RAM
E2	FP ROM	Front Panel ROM checksum
E3	EE CHKSUM	EEPROM
E4		(Not used)
E5		(Not used)
E6		(Not used)
E7		(Not used)
E8	SEC RAM	Secondary RAM
E9	SEC ROM	Secondary ROM checksum
E10	SEC 5V	Secondary 5 V ADC reading
E11	TEMP	Secondary ambient thermistor reading
E12	DACS	Secondary VDAC/IDAC readback

Checksum Errors.

If the display shows **EE CHKSUM**, the power supply has detected an EEPROM checksum error. A checksum error can occur due to the following conditions:

- Excessive number of write cycles to an EEPROM (see "Supplemental Characteristics"). This condition, which would appear only after extended use, is not recoverable and requires service.
- Loss of ac input power during a checksum calculation. This condition, which is very unlikely, is recoverable.

You may be able to recover from a checksum error by writing to the EEPROM while the power supply is in the calibration mode. To do this, proceed as follows:

1. Enable the calibration mode by pressing **Cal Enable** **Shift** **1** **Enter**.
2. **PASWD** will appear on the display.
3. Press the number keys corresponding to the password, followed by **Enter**. The **Cal** annunciator will go on.

Note

On new equipment, the calibration password corresponds to the four- digit model number (such as **6 5 5 2**). See Appendix A for more information about the calibration password.

4. Save any operating state (for example, press **Save** **0** **Enter**)
5. Turn the power off and then back on.

A normal display free of error messages should appear. If not, the power supply requires service.

Runtime Error Messages

Under unusual operating conditions, the **VOLT** or **AMPS** display may show **+OL** or **-OL**. This indicates that the output voltage or current is beyond the range of the meter readback circuit.

Table 3-4 shows other error messages that may appear at runtime.

Table 3-4. Runtime Errors

Display	Meaning
EE WRITE ERR	EEPROM status time-out
SBUB FULL	Message too long for buffer
SERIAL DOWN	Failed communication with front panel
STK OVERFLOW	Front panel stack overflow
UART FRAMING	UART byte framing error
UART OVERRUN	Overfilled UART receive buffer
UART PARITY	UART byte parity error

User Connections and Considerations

Rear Panel Connections

WARNING

Shock Hazard Disconnect ac power before making rear panel connections.

Application connections are made to the output terminals and analog connector. The connections are the same for Series 654xA and 655xA supplies and similar for the Series 657xA supplies. Unless otherwise specified, instructions in this chapter apply to all models.

Output Connectors

The + and - load connections are made at the rear panel. Depending on the model (see Figure 4-1 or Figure 4-2), either terminals or screw-down bus bars (+ and -) connect the load to the power supply. The general procedure is as follows:

1. Remove the output safety cover.
2. Connect the load wires.
3. Replace the output safety cover.

For more specific information, refer to the following applicable paragraph.

Series 654xA and 655xA Supplies

- On Series 654xA:
 - strip the end of each load wire and secure it to the appropriate terminal, using the screw provided on the terminal.
- On Series 655xA:
 - strip the end of each load wire and fasten a suitable terminal lug to the end.
 - using the screws provided on the output bus bars, attach the wire terminal lugs to the bus bars.

Series 657xA Supplies

- strip the end of each load wire and fasten a suitable terminal lug to the end.
- make a suitable opening in the output safety cover by removing one or more cover knockouts (see Figure 4-2).

WARNING

Do not leave uncovered holes in the safety cover. If too many knockouts have been removed, install a new cover (see Table 1-3).

- feed the wires through the safety cover.
- using the screws provided on the output bus bars, attach the wire terminal lugs to the bus bars.

Analog Connector

The rear panel has a 7-pin analog connector with quick-disconnect plug (see Figure 4-3) for making the following optional connections:

- remote sense leads
- an external current monitor
- an external programming voltage source
- connecting two or more power supplies in auto-parallel

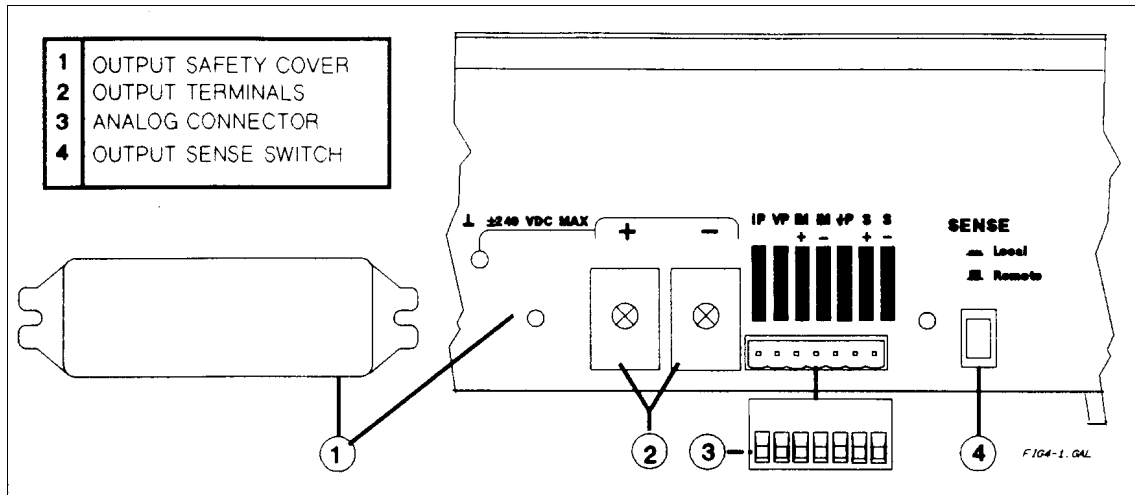

Figure 4-1. Series 654xA and 655xA Rear Panel Connections

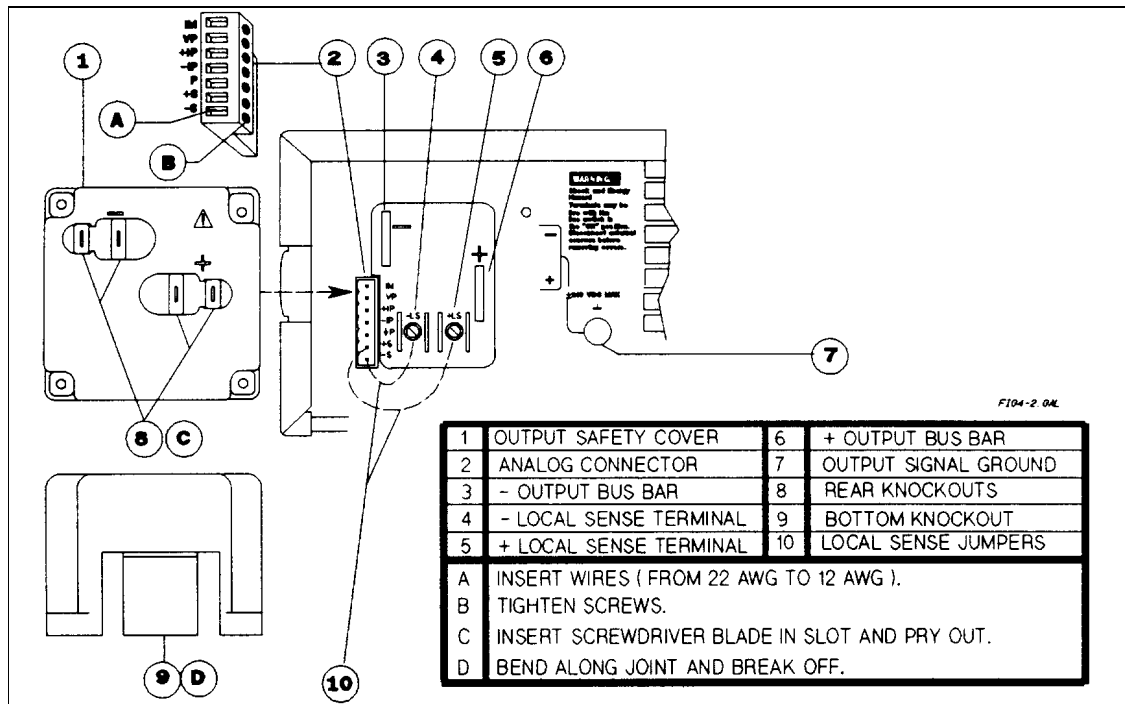

Figure 4-2. Series 657xA Rear Panel Connections

The connector accepts wire sizes from AWG 22 to AWG 12. The purpose of each analog pin is described in Table 4-1.

Note

In addition to specific wiring instructions given in this chapter, it is good engineering practice to twist and shield all signal wires to and from the analog connector.

Table 4-1. Analog Connector Functions

Pin	Function
IP	Series 654xA and 655xA Current programming Input. Allows an external voltage source to program CC (constant current) mode. CC is programmed with a 0 to -5 V signal that produces proportional output current from zero to full scale. The IP input is also used for auto-parallel operation as described later in this chapter.
±IP	Series 657xA Differential Current Programming Input. Allows an external voltage source to program CC (constant current) mode. ±IP accepts a signal (see <i>Analog Programming</i> in Table 1-2b) that produces a proportional output current from zero to full scale. +IP is positive with respect to -IP. -IP may be floated up to ±19 V from the Common P (↓P) terminal, which is approximately at the same potential as the + output. The ±IP input is also used for auto-parallel operation as described later in this chapter.
VP	Voltage Programming Input. Allows an external voltage source to program CV (constant voltage) mode. CV is programmed with a signal (see <i>Analog Programming (IP & VP)</i> in “Supplemental Characteristics”) that produces a proportional output voltage from zero to full scale.
+IM	Series 654xA and 655xA Current Monitor Output. Monitors the output current with respect to Common P (↓P). A 0 to -5 V signal at this output indicates a zero-to-full scale current. +IM is also used when connecting supplies in autoparallel for increased current output (see “Auto-Parallel Operation”).
-IM	Series 654xA and 655xA Current Monitor Input. Connects to Common P (↓P) when connecting supplies in autoparallel for increased current output (see “Auto-Parallel Operation”).
IM	Series 657xA Current Monitor Output. Monitors the output current with respect to Common P (↓P). A signal (see <i>Current Monitor (IM)</i> in Table 1-2b) at this output indicates a zero-to-full scale current. +IM is also used when connecting supplies in autoparallel for increased current output (see “Auto-Parallel Operation”).
Common P (↓P)	Series 654xA and 655xA Common Return. Provides the common connection for the IP and VP programming inputs and the +IM current monitor output.
Common P (↓P)	Series 657xA Common Return. Provides the common connection for the VP programming input and the IM current monitor output.
±S	Series 654xA and 655xA Remote Sense Inputs. Connects the load sense input leads to the power supply when the rear panel Remote Sense switch is in the Remote position (see “Remote Sensing”).
±S	Series 657xA Sense Inputs. Connects the power supply sense input to either the +LS and -LS terminals for local sensing (see “Local Voltage Sensing”) or to the load for remote sensing (see “Remote Voltage Sensing”).
After you have finished making the analog connections, insert the plug back into the analog connector and replace the output safety cover.	

Wire Size Selection

The minimum wire size required to prevent wire overheating still may not be large enough to maintain a small enough load-lead voltage drop for good electrical performance. See “Remote Sensing” and “OVP Considerations” for more information on this topic. Table 4-2 gives the wire resistance for various stranded sizes to help you determine load-lead drop.

WARNING	Fire Hazard To satisfy safety requirements, load wires must be heavy enough not to overheat when carrying the maximum short-circuit current of the power supply.
----------------	---

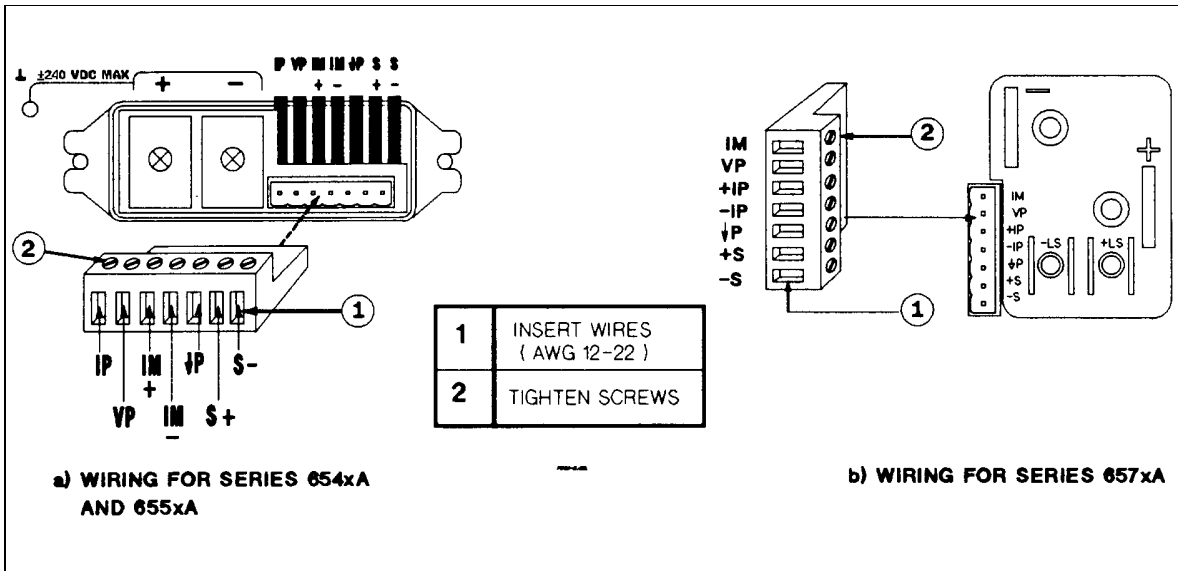

Figure 4-3. Analog Connector

Table 4-2. Stranded Copper Wire Ampere Capacity and Resistance

AWG No.	Area (mm ²)	Ampacity	Resistance (W/m)	AWG No.	Area (mm ²)	Ampacity	Resistance (W/m)
18	0.82	15.4	0.0210	8	8.37	75	0.0020
16	1.31	19.4	0.0131	6	13.3	100	0.0013
14	2.08	31.2	0.0082	4	21.1	135	0.0008
12	3.31	40.0	0.0052	2	33.2	180	0.0005
10	5.26	55.0	0.0033	1/0	53.0	245	0.0003

Note:

1. AWG wire rating derived from MIL-W-5088B.
2. Ampacity of aluminum wire is approximately 84% that of copper wire.
3. With bundled wires, use the following percentages of the rated ampacity:

2 conductors 94%	4 conductors 83%
3 conductors 89%	5 conductors 76%
4. Maximum temperatures. ambient = 50° C; conductor = 105° C.

Output Isolation

The output of the power supply is isolated from earth ground. Either output terminal may be grounded, or an external voltage source may be connected between either output and ground. However, both output terminals must be kept within ± 240 Vdc of ground. An earth ground terminal is provided on the rear panel for convenience, such as grounding wire shields.

WARNING

The earth ground terminal on the rear panel is a low-noise signal ground for convenience only. It is not designed to function as a safety ground.

Load Considerations

Capacitive Loads

In most cases, the power supply will continue to be stable with additional external load capacitors (see the following table for Series 654xA/665xA recommendations). However, large load capacitors may cause ringing in the supply's transient response. It is possible that certain combinations of load capacitance, equivalent series resistance, and load lead inductance will result in instability. If you need help in solving a stability problem, contact an Agilent service engineer through your local Sales and Support office (see end of this manual).

Series 654xA/655xA Power Supplies, Maximum External Capacitance

6541A	6542A	6543A	6544A	6545A	6551A	6552A	6553A	6554A	6555A
40,000µF	20,000µF	12,000µF	7,000µF	3,000µF	100,000µF	50,000µF	30,000µF	18,000µF	8,000µF

If the power supply output is rapidly programmed into capacitive loads, the supply may momentarily cross into CC mode. This extends the CV programming time and limits the maximum slew rate to the programmed current divided by the total internal (see "Inductive Loads") and external capacitance. These momentary crossovers into CC mode will not damage the supply.

Inductive Loads

Inductive loads provide no loop stability problems in CV mode. However, in CC mode inductive loads will form a parallel resonance network with the power supply's output capacitor. Generally, this will not affect the stability of the supply, but it may cause ringing of the current in the load. Ringing will not occur if the Q (quality factor) of the parallel resonant network is ≤ 0.5 . Use the following formula to determine the Q of your output.

$$Q = \frac{1}{R_{\text{int}} + R_{\text{ext}}} \sqrt{\frac{L}{C}}$$

where C = model-dependent internal capacitance (see below); L = inductance of the load; R_{ext} = equivalent series resistance of the load; R_{int} = model-dependent internal resistance (see below):

	6541A	6542A	6543A	6544A	6545A	6551A	6552A	6553A	6554A
C=	4,200µF	550µF	180µF	68µF	33µF	10,000µF	1,100µF	440µF	120µF
R_{int} =	7 mΩ	30 mΩ	50 mΩ	125 mΩ	300 mΩ	4 mΩ	20 mΩ	30 mΩ	80 mΩ
	6555A	6571A	6572A	6573A	6574A	6575A			
C=	50µF	44,000µF	44,000µF	12,000µF	7,000µF	2,100µF			
R_{int} =	250 mΩ	1.8 mΩ	2.2 mΩ	4 mΩ	14 mΩ	30 mΩ			

Note for Series 657xA Supplies: If $Q > 0.5$, inductive loads will ring with the output capacitance and be damped according to the following equation

$$e^{\left(\frac{-t}{\left(\frac{2L}{R}\right)}\right)} \sin \omega t \sqrt{1 - \left(\frac{1}{2Q}\right)^2}$$

Multiple Loads

When connecting multiple loads to the power supply using local sensing, use separate wires to connect each load to the output terminals (see Figure 4-4). This minimizes mutual coupling effects and takes full advantage of the power supply's low output impedance. Each pair of wires should be as short as possible and twisted or bundled to reduce lead inductance and noise pickup.

If cabling considerations require the use of distribution terminals that are remotely located from the supply, connect the output terminals to the distribution terminals by a pair of twisted or bundled wires. Use separate wires for connecting each load to the distribution terminals. In these circumstances, remote voltage sensing is recommended (see "Remote Voltage Sensing"). Sense either at the remote distribution terminals or, if one load is more critical than the others, directly at the critical load (see dashed lines in Figure 4-1). Note that the power supply's voltage readback occurs at the sense terminals.

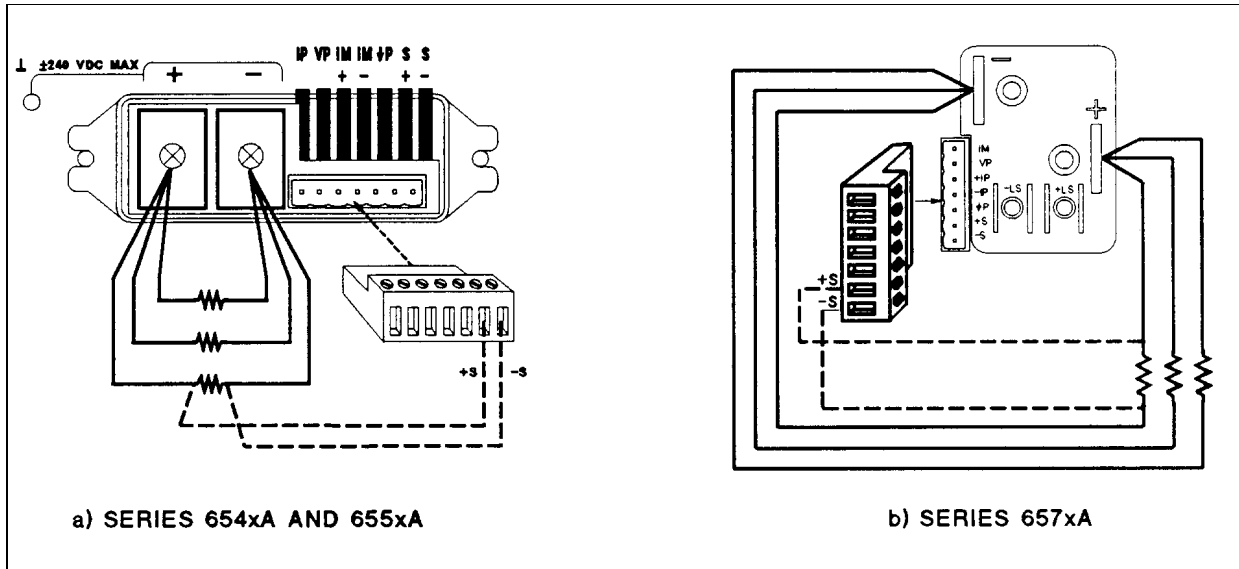

Figure 4-4. Multiple Load Connections (Remote Sensing Optional)

Local Voltage Sensing

Your power supply was shipped set up for local sensing. This means that the supply will sense and regulate its output at the output terminals, not at the load. Since local sensing does not compensate for voltage drops across screw terminals, bus bars, or load leads, local sensing should only be used in applications that require low output current or where load regulation is not critical.

Series 654xA and 655xA Supplies

Local sensing is obtained by placing the **SENSE switch** (see Figure 4-1) in the **Local** position. The power supply is shipped with the switch in this position.

Series 657xA Supplies

Local sensing is obtained by connecting the **+LS** sense terminal to the **+S** analog connector pin and the pin and the **-LS** sense terminal to the **-S** analog connector pin. The power supply is shipped with these connections made.

Note

If the sense terminals are left unconnected, the voltage at the bus bars will increase approximately 3 to 5 % over the programmed value. Since it is measured at the sense terminals, the voltage readback will not reflect this increased output.

Remote Voltage Sensing

The dashed lines in Figure 4-4 illustrate a typical power supply setup using remote voltage sensing. In this case, the remote sense terminals of the power supply are connected directly to the load rather than to the output terminals. This allows the supply to automatically compensate for the voltage drop in the load leads as well as to accurately read back the voltage directly across the load.

Setting Up Remote Sense Operation

Series 654xA and 655xA Supplies

Remote sensing is obtained by placing the **SENSE switch** (see Figure 1-1) in the **Remote** position. The power supply is shipped with the switch in the **Local** position.

Series 667xA Supplies

Remote sensing is obtained by removing the jumpers connecting the **+LS** sense terminal to the **+S** analog connector pin and the **-LS** sense terminal to the **-S** analog connector pin. The power supply is shipped with these jumpers connected.

Connecting the Sense Leads

You must connect the positive side of the load to the **+S** analog connector pin and the negative side of the load to the **-S** analog connector pin (see Figure 4-3). Connect the sense leads carefully so that they do not become open-circuited. If sense leads are left open during operation, the supply will regulate at the output terminals instead of at the load. Remember to bundle or tie wrap the load leads to minimize inductance and reduce noise pickup.

CV Regulation

The voltage load regulation specification in “Performance Specifications” applies at the output terminals of the power supply. When remote sensing, this specification must be compensated as follows.

Series 654xA and 655xA Supplies

Add 3 mV to the voltage load regulation specification for each 1-volt change in the positive load lead due to a change in load current. Because the sense leads are part of the supply's feedback path, keep the resistance of the sense leads at or below 0.5 Ω to maintain the above specified performance.

Series 657xA Supplies

Add an increment to the voltage load regulation specification as specified by “ ΔmV ” in the equation given under *Load regulation* in Table 1-2b.

Output Rating

The rated output voltage and current specification in “Performance Specifications” applies at the output terminals of the power supply. With remote sensing, any voltage dropped in the load leads causes the supply to increase the voltage at the output terminals so it can maintain the proper voltage at the load. When you attempt to operate at the full-rated output at the load, this forces the supply voltage at the output terminals to exceed the supply's rated output. This will not damage the supply, but may trip the OVP (overvoltage protection) circuit, which senses the voltage at the output. When operated beyond its rated output, the supply's performance specifications are not guaranteed, although typical performance may be good. If the excessive demand on the supply forces it to lose regulation, the **Unr** annunciator will indicate that the output is unregulated.

Output Noise

Any noise picked up on the sense leads also appears at the output of the power supply and may adversely affect the load voltage regulation. Be sure to twist the sense leads to minimize external noise pickup and route them parallel and close to the load leads. In noisy environments, it may be necessary to shield the sense leads. Ground the shield only at the power supply. *Do not use the shield as one of the sense conductors*

Note **Agilent 657xA Series** - The signal ground binding post on the rear panel is a convenient place to ground the sense shield.

Stability

Using remote sensing under unusual combinations of load-lead lengths and large load capacitances may cause your application to form a low-pass filter that becomes part of the voltage feedback loop. The extra phase shift created by this filter can degrade the supply's stability and result in poor transient response. In severe cases, this may cause output oscillations. To minimize this possibility, keep the load leads as short as possible and tie wrap them together.

In most cases, following the above guidelines will prevent problems associated with load lead inductance. This leaves load lead resistance and load capacitance as the major source of reduced stability. Further improvement to the stability of the supply may be obtained by keeping the load capacitance as small as possible and by decreasing the load-lead resistance by using larger diameter wires. However, if heavy gauge wire (\geq AWG 10) is used, conditions may arise where the load-lead inductance and load capacitance can form an undamped filter. This can actually reduce the damping in the system and create a destabilizing phase response.

Note If you need help in solving a stability problem with any Series 654xA, 655xA, or 657xA supply, contact an Agilent Service Engineer through your local Agilent Sales and Support office.

Series 657xA Network

If a large bypass capacitor is required at the load and the load-lead length cannot be reduced, then a sense-lead bypass network may be needed to ensure stability (see Figure 4-5). The voltage rating of the 33 μ F capacitors should be about 50% greater than the anticipated load-lead drop. Addition of the 20- Ω resistors will cause a slight voltage rise at the remote sensing points. For utmost voltage programming accuracy, the supply should be recalibrated with the DVM at the remote sensing points (see Appendix A).

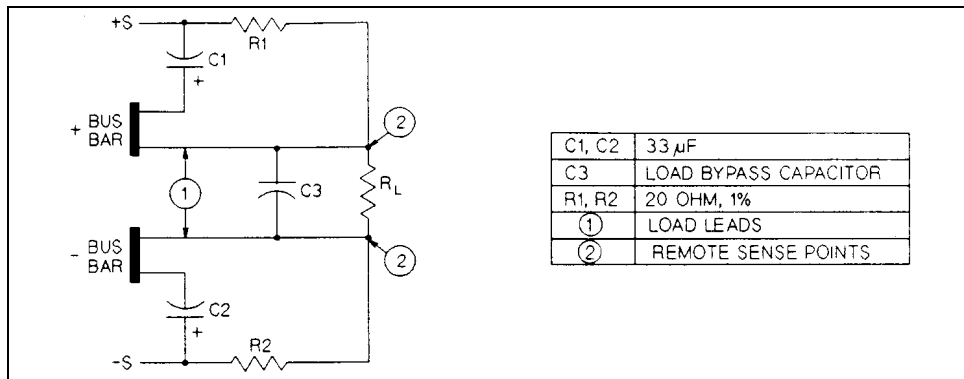

Figure 4-5. Series 657xA Sense Lead Bypass Network

Operating Considerations

Auto-Parallel Operation

Auto-Parallel Wiring

Figure 4-6 illustrates how power supplies can be connected in auto-parallel for increased current output. You can connect supplies of the *same model* in auto-parallel as follows:

- Series 654xA or 655xA - up to three supplies.
- Series 657xA - up to five supplies.

Use load leads of a sufficient wire size so that the absolute voltage difference between the + output terminal of the “master” supply and the + output terminal of the first “slave” supply is kept under 2 V at rated current. This also applies to the voltage difference between the + output terminals of the first and second slave supplies. If remote sensing is required, connect the load to the remote sense terminals *of the master supply*, as shown by the dashed lines in Figure 4-6.

Note

To avoid output oscillations with Series 654xA and 655xA supplies, observe the wiring suggestions given under “External Voltage Control”.

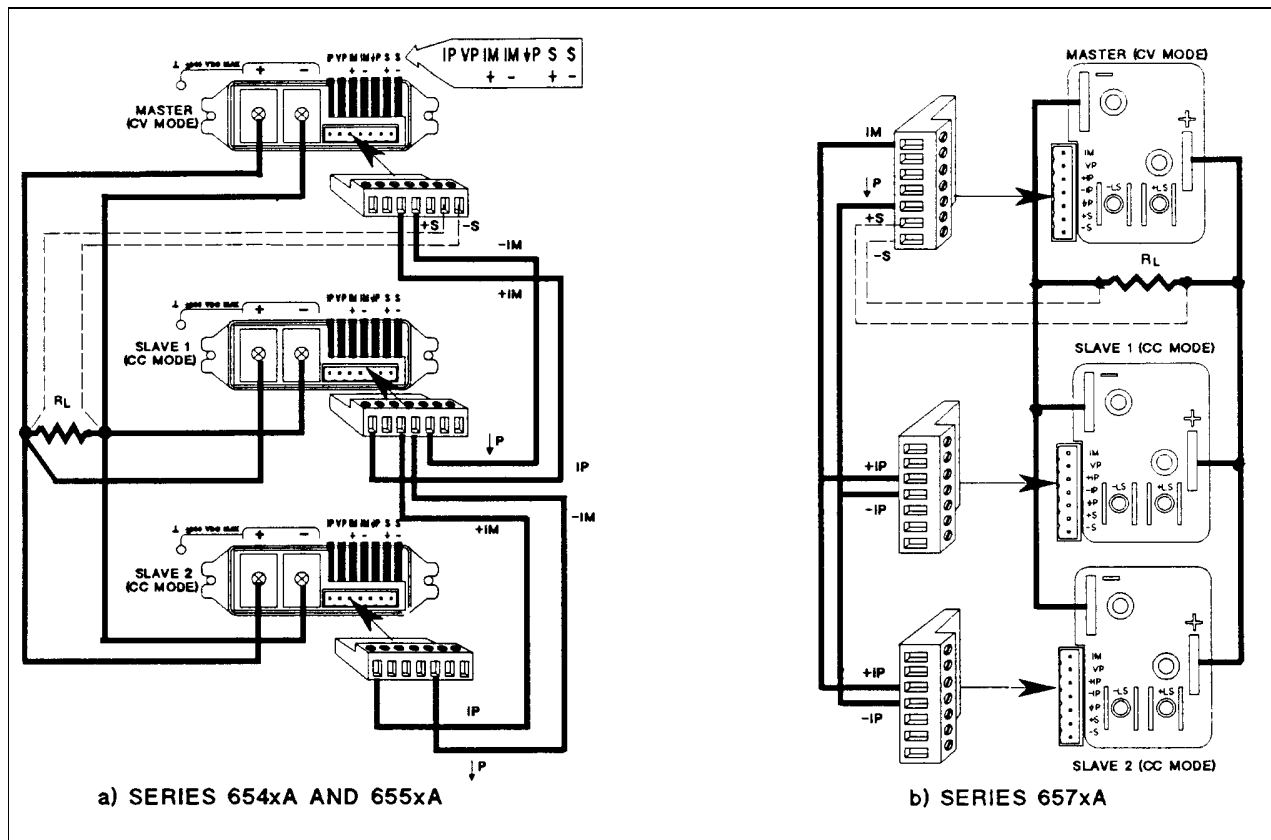

Figure 4-6. Connecting Power Supplies in Auto-Parallel

General Auto-Parallel Programming

Program only the first (“master”) supply in the series; the “slave” supplies automatically track the master's output. However, the voltage and OVP settings of the slave supplies must be set higher than the operating voltage of the master supply. This ensures that the slave supplies will operate in CC mode.

Series 654xA and 655xA Auto-Parallel Programming



Follow the following operating precautions if you are connecting **three** of these models in auto-parallel.

You must use caution when connecting three Series 654xA and 655xA power supplies for auto-parallel operation. That is because of the OVP crowbar circuits within these supplies. If the OVP circuit of the second “slave” trips, its crowbar circuit will draw current from the other two supplies. Although some models can withstand this current, the higher-current models in each series (particularly the Agilent 6651A) may be damaged in this situation. Use any of the following operating techniques to avoid possible problems.

Program Slave 2 OVP to the Maximum Level.

The following technique minimizes the chance that the slave 2 OVP circuit will trip.

1. Program the OVP level of the master and of slave 1 to the desired protection level (below the maximum level specified in Table 1-2b).
2. Program the OV protection level of slave 2 to its maximum value.

Enable OCP on the Master.

You can do this if the combination of all three supplies is being used in the CV mode and the CC mode is only being used as a current limit. Enable OCP on the master supply. If the OVP on either slave trips it will drive the master into CC mode, thereby tripping its OCP. This will shut down all three supplies. This technique will work unless the system is programmed for very low (0.5 to 1.5) output voltages.

Insert Protection Diodes.

If you connect the slave 2 supply to the load through a series diode (see Figure 4-7), its OVP circuit will not draw current from other supplies. Be certain to increase the programmed CV level of slave 2 by at least 0.7 V to compensate for the voltage drop in the diode.

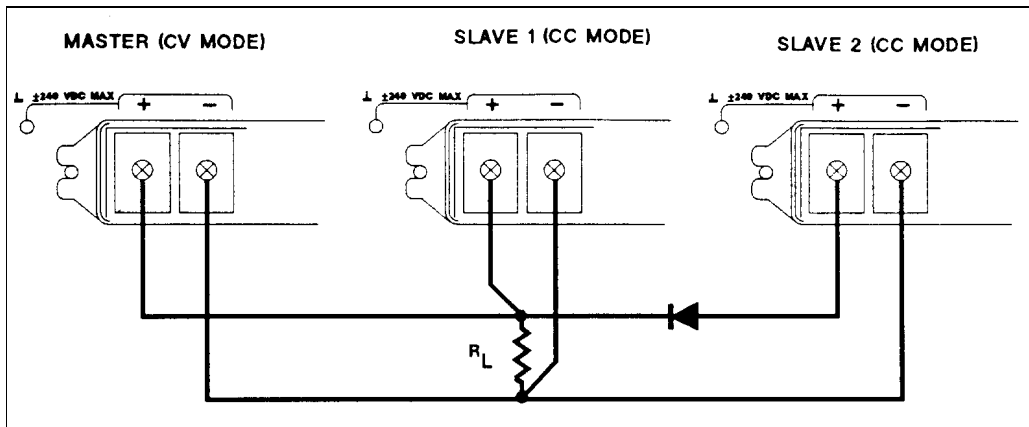

Figure 4-7. Using Series Diodes with Series 654xA/655xA Auto-Parallel Operation

Note

Removing or disabling the power supply OVP crowbar SCR is another possibility. For further information, contact an Agilent Service Engineer through your local Agilent Sales and Support office.

Series Operation

WARNING

Floating voltages must not exceed 240 Vdc. No output terminal may be more than 240 V from chassis ground.

Figure 4-8 shows how power supplies can be connected in series for higher voltage output. Series connections are straightforward in this case.

Program each power supply independently. If two supplies are used in the series configuration, program each supply for 50% of the total output voltage. Set the current limit of each supply to the maximum that the load can handle without damage.

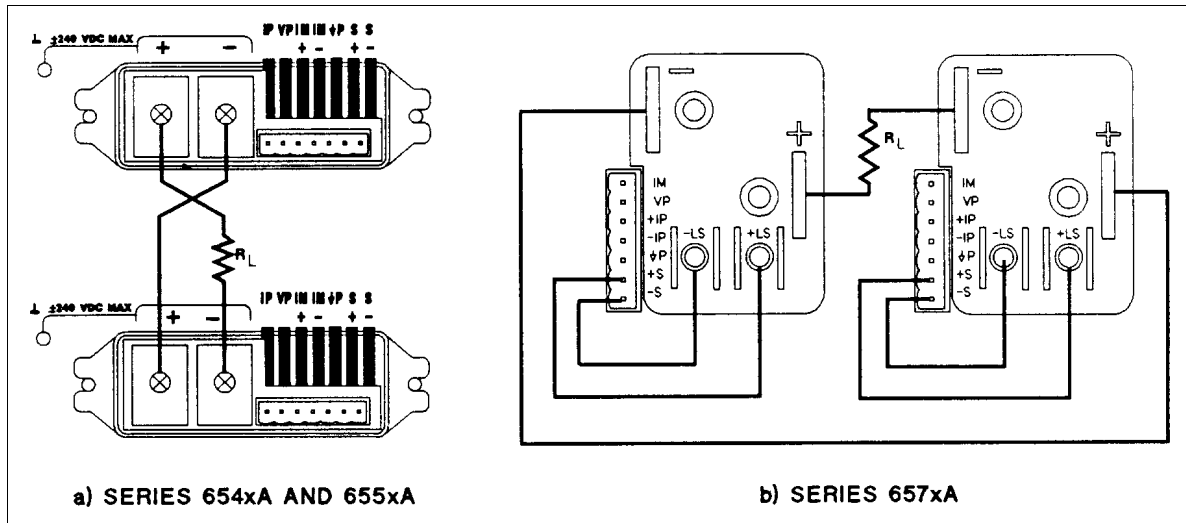

Figure 4-8. Connecting Power Supplies in Series

CAUTION

Each power supply has a reverse voltage protection diode across its output. If a reverse voltage is applied, the supply cannot control the current conducted through this diode. To avoid damaging the supply, never connect it in such a way that a reverse voltage can force it to conduct current in excess of the supply's maximum reverse diode current (see "Supplemental Characteristics").

External Voltage Control

The setup shown in Figure 4-9 allows an external dc voltage to program the power supply output. A voltage applied to the voltage programming input programs the output voltage and a voltage applied to the current programming input programs the output current. See Figure 4-3 and Table 4-1 for an explanation of these programming input connections.

Programming Series 654xA and 655xA Supplies

Wiring Considerations

The input impedance of the analog input is 10 k Ω . If the output impedance of your programming source is not negligible with this, programming errors will result. Larger output impedances result in proportionally greater errors.

Be careful of capacitive coupling from the programming inputs to other lines wired to the analog connector. Such coupling can cause output oscillations. You can minimize coupling by bundling the **IP**, **VP**, and **Common P** lines and keeping them separated from other wires. Twisting these three lines together is also recommended.

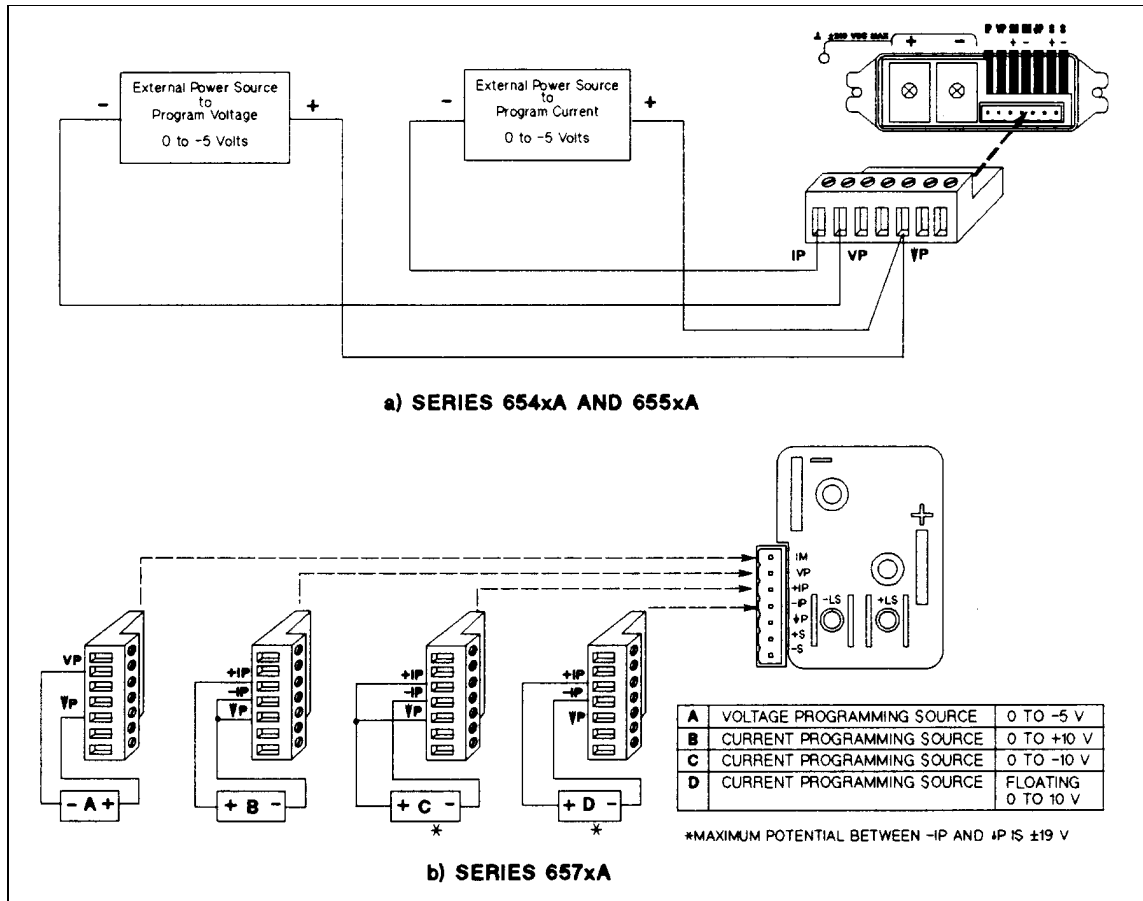

Figure 4-9. External Voltage Programming

If you cannot avoid capacitive coupling, it may help to place capacitors from the unused programming inputs to ground. Especially with auto-parallel operation, connecting a capacitor ($\geq 4,000$ pF) from **VP** to **P Common** on the master supply will ensure proper operation. Also with auto-parallel operation, do not allow more than about 500 pF capacitive loading between **IM** and **Common P**.

Programming Considerations.

When voltage programming the output, the frequency of the programming source is limited by the slew rate of the power supply. To keep the power supply from slewing its output (going into nonlinear operation), the maximum programming rate is 3750 V/s. The maximum downprogramming rate (when the power supply is sinking current) is 750 V/s. These restrictions can be expressed as the maximum programming frequency that can be applied without causing distortion at the output. The following formula can be used to determine this frequency:

$$F_{\text{MAX}} = \frac{50 \text{ (voltage rating of supply)}}{\text{p - p amplitude of desired output sine wave}}$$

At frequencies >6 kHz, voltage programming is subject to a 3 dB bandwidth limitation.

Programming Series 657xA Supplies

Wiring Considerations.

The input impedance of the analog input is over 30 k Ω . If the output impedance of your programming source is not negligible with this, programming errors will result. Larger output impedances result in proportionally greater errors.

Note from Figure 4-3 that you have three options for programming the current. You can use a voltage source that is positive, negative, or floating with respect to **Common P**. Do not exceed ± 19 V with respect to **Common P**.



Make sure that the common connection for your voltage programming source is isolated from the load. Failure to do this may cause damage to the power supply.

OVP Considerations

Remote Sensing

The OVP circuit senses the voltage near the output terminals and not at the sense terminals. Depending on the voltage drop between the output terminals and the load, the voltage sensed by the OVP circuit can be significantly higher than that actually being regulated at the load. You must program the OVP trip high enough to compensate for the expected higher voltage at the output terminals.

Battery Charging

The power supply's OVP circuit contains a circuit that discharges the output of the supply whenever the OVP trips. If a battery (or other external voltage source) is connected across the output and the OVP is inadvertently triggered or the output is programmed below the battery voltage, the power supply will continuously sink a large current from the battery. This could damage the supply. To avoid this, insert a reverse blocking diode in series with the + output of the supply. Connect the diode cathode to the + battery terminal and the diode anode to the supply + output terminal. The diode may require a heat sink.

Series 654xA and 655xA Load Capacitance

For Series 654xA and 655xA power supplies, the OVP circuit has been designed to discharge fully-charged capacitances up to a specified limit for each model. These limits are as follows:

6541A	6542A	6543A	6544A	6545A	6551A	6552A	6553A	6554A	6555A
700,000 μ F	35,000 μ F	15,000 μ F	7,000 μ F	3,000 μ F	1.6F	100,000 μ F	50,000 μ F	18,000 μ F	8,000 μ F

If a load capacitance approaches the specified limit, it is recommended that you do not make it a normal practice of tripping the OVP circuit and discharging the load capacitance through that circuit. This could cause long-term fatigue in some circuit components.



Because of its high output voltage, the Agilent 6555A generates very high currents when discharging the load capacitor under overvoltage conditions. Excessive currents can damage the supply. The peak discharge current is limited by the sum of the external capacitor's ESR (equivalent series resistance) and the series resistance of the external circuit. For the Agilent 6555A's external capacitance limit of 8,000 microfarads, this total resistance must be not less than 56 milliohms. For smaller values of external capacitance, this resistance may be derated linearly.

Front Panel Operation

Introduction

This chapter shows you how to operate the front panel. It is assumed that you are familiar with the turn-on checkout procedure in Chapter 3. That chapter describes how to perform basic power supply functions from the control panel. Operations that you can perform are:

- Enabling or disabling the power supply output.
- Setting the output voltage and current.
- Monitoring the output voltage and current.
- Setting the overvoltage protection (OVP) trip point.
- Enabling the overcurrent protection (OCP) circuit.
- Saving up to 5 operating states in nonvolatile memory.
- Recalling up to 5 operating states from nonvolatile memory.

Note You also can calibrate the power supply from the front panel (see Appendix A).

Getting Acquainted

The front panel is summarized in Figure 5-1. Note that the panel is organized as follows:

- ① LCD display (including annunciators)
- ② Output VOLTAGE and CURRENT rotary (RPG) controls
- ③ SYSTEM keys
- ④ FUNCTION keys
- ⑤ ENTRY keys
 - Power On-Off (LINE) switch

Some keys perform two operations. The first operation is shown **on** the key and the second (shifted) operation is shown in blue **above** the key. In order to do a shifted operation, first press the solid blue key, which is unlabeled but shown throughout this manual as **Shift**.

For example, for a recall operation, you press the recall key **Recall**. For a save operation, you press the save key, which is **Shift** **Recall**. In this chapter, such a shifted operation may be shown simply as **Save**.

The display consists of alphanumeric data and triangular-shaped annunciators (▼) along the bottom of the display.

Table 5-1. Front Panel Controls and Indicators

Control or Indicator	Function or Indication
1 Display	
VOLTS	Shows present output voltage of the power supply.
AMPS	Shows present output current of the power supply.
Status Annunciators	
CV	The power supply is in constant-voltage mode.
CC	The power supply is in constant-current mode.
Unr	The power supply output is unregulated (output is neither CV or CC).
Dis	The power supply output is disabled.
OCP	The overcurrent protection function is enabled.
Prot	A protection circuit has caused the power supply to shut down. (Press Protect to determine the reason.)
Err	(Not used ¹).
Cal	The power supply is in calibration mode.
Shift	The shift key Shift has been pressed.
Rmt	(Not used ¹)
Addr	(Not used ¹)
SRQ	(Not used ¹)
¹ These annunciators function only with the corresponding models of GPIB System family of power supplies.	
2 Output Rotary Controls	
Voltage	Rotate clockwise to increase output voltage or program setting. Provides the same function as the ↑Voltage and ↓Voltage keys.
Current	Rotate clockwise to increase output current or program setting. Provides the same function as the ↑Current and ↓Current keys.
3 SYSTEM Keys	
Local	(Not used ²)
Address	(Not used ²)
Error	(Not used ²)
Recall	Press to restore a previously saved power supply state. Use ENTRY keys 0 through 4 to specify which location to recall. (Select by pressing Shift Recall .) Use the ENTRY keys to specify the location where you want to store the state. You may use locations 0 to 4.
Save	Note: Location 0 may contain the power supply turn-on state. See “Turn-On Operation” in this chapter. Use to save the power supply's present state to nonvolatile memory. (Select by pressing Shift Recall .) Use the ENTRY keys to specify the location where you want to store the state. You may use locations 0 to 4.
	This unlabeled blue key is the Shift key. Press to access the shifted (alternate) key functions.
² These keys function only with the corresponding models of GPIB System family of power supplies. Pressing them causes NO GPIB to be displayed.	

Table 5-1. Front Panel Controls and Indicators (continued)

Control or Indicator	Function or Indication
4 Function Keys	
Output on/off	Press to enable or disable the power supply output. This key toggles between the two states. The disabled state programs the output to very low voltage and current settings.
Voltage	Press to display the output voltage setting. After pressing Voltage , you may use the ENTRY keys to change the value.
Current	Press to display the output current setting. After pressing Current , you may use the ENTRY keys to change the value.
Protect	When the Prot annunciator comes on, press Protect to see which protection circuit caused the power supply to shut down. Response can be OC (overcurrent), OT (overtemperature), or OV (overvoltage). If no protection circuit has tripped, the display will show dashes (-- -- -- --)
Prot Clear	Press this key to reset the protection circuit. If the condition that caused the circuit to trip has been removed, the Prot annunciator will go off.
OCP	Press to enable or disable the power supply OCP trip circuit. This key toggles between the to states .
OV	Press to display the OV trip voltage setting. After pressing OV , you may use the ENTRY keys to change the value.
5 ENTRY Keys	
↑Voltage	Press to increment the output voltage in the CV mode, or the voltage setting after you have pressed the Voltage key. ³
↓Voltage	Press to decrement the output voltage in the CV mode, or the voltage setting after you have pressed the Voltage key. ³
↑Current	Press to increment the output current in the CC mode, or the current setting after you have pressed the Current key. ³
↓Current	Press to decrement the output current in the CC mode, or the current setting after you have pressed the Current key. ³
³ The four incremental keys operate in two modes. Press and release for a single output change determined by the control resolution (see ‘Supplemental Characteristics’ in Chapter 1). Press and hold for an increasingly rapid output change.	
0 thru 9 .	Press to select numerical values.
-	Press to enter a minus sign.
←	Press to delete the last keypad entry. Use this key to correct one or more incorrect digits before they are entered.
Clear Entry	Press to delete an entire keypad entry and return to the meter mode. Use this key to exit from a value before it is entered.
Enter	Press to enter a value or to accept an existing value and return the display to the meter mode. The remaining shifted keys are for calibration (see Appendix A).

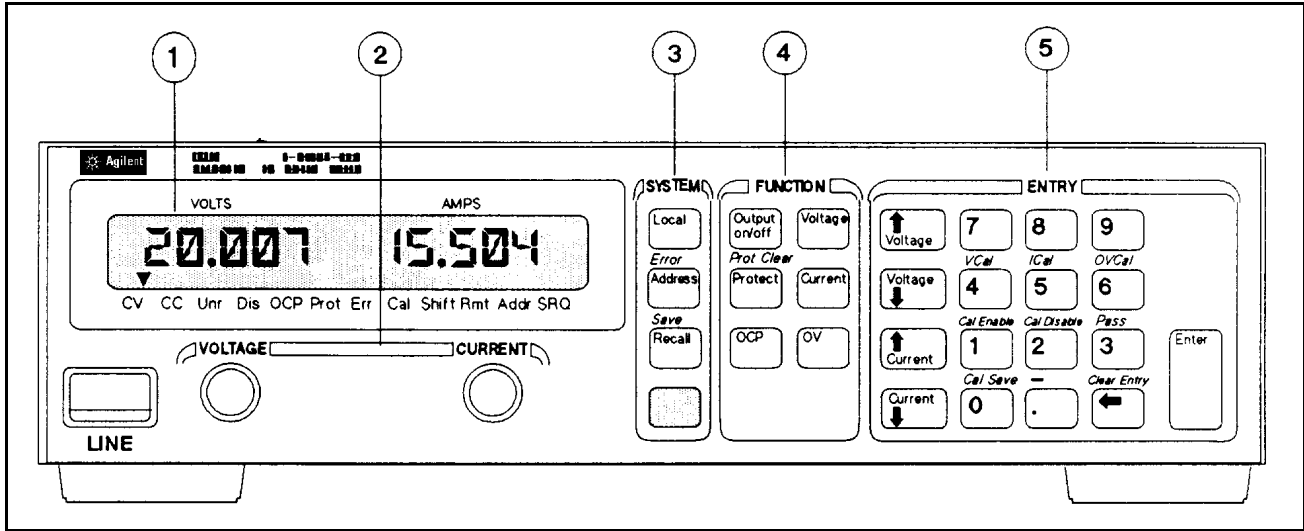

Figure 5-1. Front Panel Controls and Indicators

Programming The Output

Introduction

Important These instructions show how to program a single power supply. There are special considerations when you have two or more supplies connected in series or in auto-parallel. See “Chapter 4 - User Connections and Considerations”.

The power supply accepts values directly in volts and amperes. Values will be rounded off to the nearest multiple of the output resolution (see “Average Resolution” in “Supplemental Characteristics” of Chapter 1). If you attempt to enter a value not in a valid range, the entry will be ignored and **OUT OF RANGE** appears on the display.

Figure 5-2 shows the general response of a typical power supply. Note that the Series 654xA and 655xA supplies have a small negative current area. This is for downprogramming purposes. Always keep the output current within the positive area and within the boundaries of the particular operating line for the specified mode of operation (CV or CC).

Establishing Initial Conditions

Set the power supply to the following conditions by pressing the specified keys as required:

Zero voltage output	Voltage 0 Enter
Minimal current output	Current . 5 Enter
Dis annunciator off	Output on/off (If needed)
OCP annunciator off	OCP (If needed)
Prot annunciator off	Shift Protect (If needed)

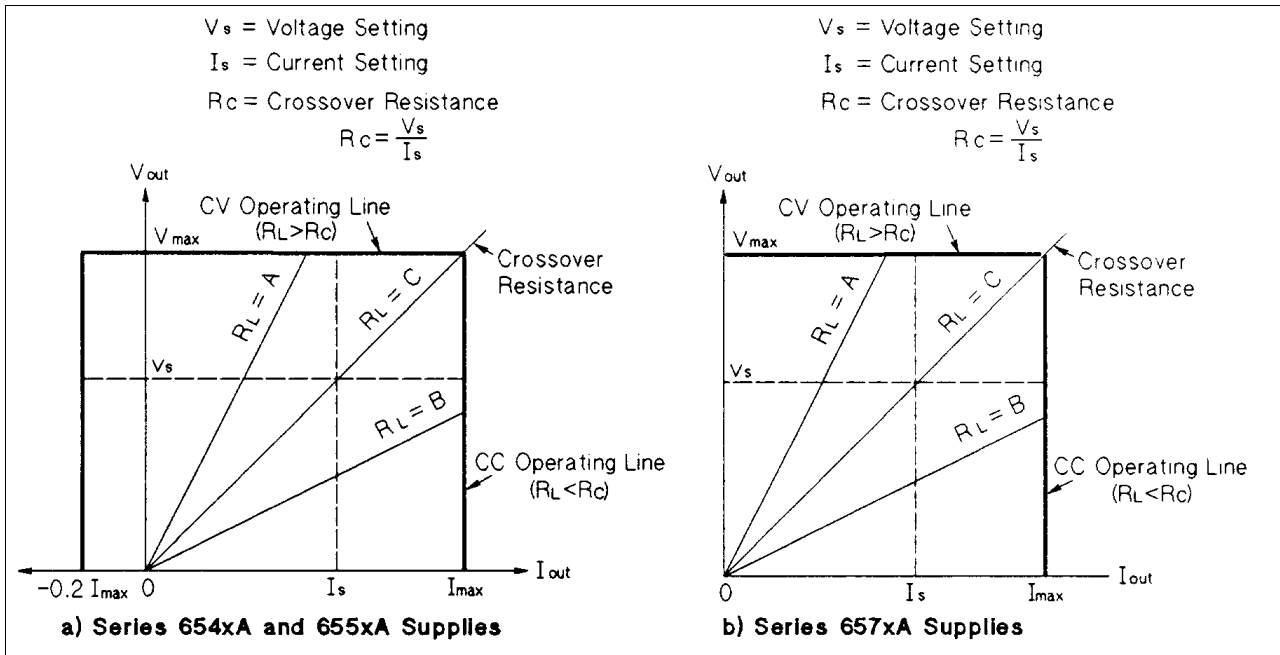

Figure 5-2. Typical Power Supply Operating Curve

Programming Voltage

To program the output for 4.5 volts, proceed as follows:

- Press **Voltage**. The display will change from meter mode to indicate VOLTS.
- Press **4** **.** **5** **Enter**. If you discover a mistake before pressing **Enter**, erase the incorrect value with the backspace key **←**.
- The display will return to the meter mode and indicate 4.5000 volts.

Note

The power supply must be programmed for a minimal current in order to increase the output voltage beyond zero. Normally, there is sufficient current to do this. If the power supply does not respond or the **Unr** annunciator comes on, go to “Programming Current” and set the current to a small value.

Now raise the voltage by pressing **↑Voltage** (or rotating the **Voltage** control clockwise). Note that the voltage increases by a specific increment (depending on the voltage resolution) each time you press the key and increases rapidly as you hold down the key. To lower the voltage, press **↓Voltage** or rotate the **Voltage** control counterclockwise. Try to program a voltage greater than the V_{MAX} for your supply. Note that the display shows **OUT OF RANGE**.

Programming Current

Note

You may program the power supply current without a load, but must have a load in order to draw output current. If you do not have a load on the power supply, you may connect a short across the output terminals for this procedure. **Turn the power supply off before making any connections.**

To program the output current to 1.3 amperes, proceed as follows:

- Make certain that the voltage is not programmed to zero.
- Press **Current**. The display will change from meter mode to indicate AMPS.

- Press **1** **0** **3** **Enter**. If you discover a mistake before pressing **Enter**, erase the incorrect value with the backspace key **←**.
- The display will return to the meter mode and indicate up to 1.3000 amperes, depending upon the load.

Now raise the current by pressing **↑Current** (or rotating the **Current** control clockwise). Note that the current increases by a specific increment (depending on the current resolution) each time you press the key and increases rapidly as you hold down the key. To lower the current, press **↓Current** rotate the **Current** control counterclockwise.

Try to program a current greater than the I_{MAX} for your supply. Note that the display shows **OUT OF RANGE**.

CV Mode vs. CC Mode

Once you program a voltage (V_s) and a current (I_s), the power supply will try to maintain itself in either CV or CC mode, depending on the resistance of the load (R_L). If the load demands less current than I_s , operation will be in CV mode with the voltage maintained at V_s . The output current will be at some value below I_s as determined by $V_s \div R_L$.

For an Agilent 6552A supply, $I_{MAX} = 25.594$ amperes and $V_{MAX} = 20.475$ volts. If you program the output for ≤ 25 amperes at 20 volts, the supply will operate in the CV mode for all resistances > 0.8 ohms. This represents the operating resistance shown as $R_L = C$ in Figure 5-2. The supply will vary the output current to maintain a constant voltage of 25 volts. If the load resistance is < 0.8 ohms, the supply will vary its output voltage to maintain a constant current output of 25 amperes. However, if you reprogram the output voltage to a lower value V_s (see Figure 5-2), then the supply will again be able to maintain CV operation with the lesser load resistance, such as $R_L = B$ in Figure 5-2.

Programming Overvoltage Protection

Overvoltage protection guards the load against voltages that reach a specified value above the programmed output voltage.

Setting the OVP Level

Assuming that a power supply is programmed for 10 volts, you can set the OVP level to 11.5 volts as follows:

- Press **OV**. The display will change from meter mode to indicate **0V**, followed by the present OVP value.
- Press **1** **1** **5** **Enter**.
- The display will return to the meter mode and indicate the output (10.000 volts).
- Press **OV** again. The display will now indicate **0V 11.500**.
- Press **Enter** to return to the meter mode.

Checking OVP Operation

Assuming the above operating conditions, trip the OVP circuit as follows:

- Raise the output voltage close to the trip point, such as 11.0.
- Gradually increase the output voltage by pressing **↑Voltage** until the OVP circuit trips. This will cause the output voltage to drop to zero and the **Prot** annunciator to go on.
- There now is no power supply output due to an overvoltage condition.
- To verify this, press **Protect** and observe that the display indicates **0V**.

Clearing the OVP Condition

With the OVP tripped, return to the meter mode and try to clear the condition by pressing **Prot Clear**. Nothing will appear to happen because the CV trip point is still below the programmed output voltage. Thus, as soon as the circuit is cleared, it trips again. You can clear the OV condition by:

- lowering the output voltage below 11.5 (the OV setting),
- or by raising the OV trip voltage above the output voltage setting.

Try either of these methods. Now when you press **Prot Clear**, the **Prot** annunciator will go off and the output voltage will return to normal.

Note In Series 654XA and 655XA supplies, the OVP circuit shorts the power supply output through an SCR. If the load maintains current through the SCR, the above methods will not clear an OVP trip condition. You must first remove the external current source before attempting to clear OVP.

Programming Overcurrent Protection

When enabled, overcurrent protection removes the power supply output whenever it goes into CC operation. This prevents the supply from indefinitely supplying the full programmed current to the load.

Setting the OCP Protection

To activate overcurrent protection, press **OCP**. The **OCP** annunciator will come on and power supply will continue to operate normally until it is forced into CC operation. If that occurs, the power supply will remove its output.

Checking OCP Operation

The easiest way to check this operation at any specified current is to place a short across the output. If the supply is connected to an Agilent Electronic Load, press its key. The power supply output will then drop to zero and the **Prot** annunciator will come on.

There is now no power supply output due to an overcurrent condition. To verify this, press **Protect** and observe that the display indicates 0C.

Clearing the OCP Condition

With the OCP tripped, return to the meter mode and try to clear the condition by pressing **Prot Clear**. Nothing will appear to happen because the reason for the condition has not been removed. Thus, as soon as the circuit is cleared, it trips again. You can clear the OC condition by:

- increasing the load resistance to lower the output current below the programmed current value,
- or by raising the programmed current to a value above that required by the load.

In this example, the easiest way to clear the OCP fault is by removing the short from across the output. After doing this, you clear the OVP circuit by pressing **Prot Clear**. The **Prot** annunciator will go off and the power supply output will be restored to normal.

If desired, you can also restore the output by disabling the OCP function (press **OCP**) to turn off the **OCP** annunciator. This restores the output but does not clear any condition that may have caused OCP to trip.

Note Under certain conditions, the OCP circuit may fail to clear because load demand occurs before the power supply has time to build up the required output current capacity. In such cases, disable the output (press **Output on/off**) before clearing the OCP circuit. After OCP is cleared, enable the power supply output.

Unregulated Operation

If the power supply goes into a mode of operation that is neither CV nor CC, the **Unr** annunciator will come on. An unregulated condition limits the output current to a value that is safe for the supply. Some unregulated states occur so briefly that they do not turn on the **Unr** annunciator. One condition that can cause a noticeable unregulated state is low ac line voltage.

Saving and Recalling Operating States

Normal Operation

You can save programming time by storing up to 5 power supply operating states in nonvolatile memory. The programming parameters that are saved are:

- Output voltage Output current *OVP voltage
- OCP state (on or off) Output state (enabled or disabled)

As an example, set up the following state:

- Voltage = 4 V Current = 1 A OVP voltage = 5.5 V
- OCP = on (**OCP** annunciator on) Output = Off (**Dis** annunciator on)

Save the above state to location 1 by pressing **Save** **1** **Enter**.

Now set up the following state:

- Voltage = 8 V Current = 1.5 A OVP voltage = 8.5 V
- OCP = off (**OCP** annunciator off) Output = On (**Dis** annunciator off)

Save the above state to location 2 by pressing **Save** **2** **Enter**.

Now restore the first state by pressing **Recall** **1** **Enter** and verify the parameters. Restore the second state by pressing **Recall** **2** **Enter**. Note how the power supply is automatically programmed each time.

Turn-On Operation

Whenever you apply power to a new power supply it automatically turns on in a safe reset state with the following parameters:

- **Output** off **Voltage** minimum **Current** near zero
- **OV** maximum **OCP** off

It is recommended that you leave the turn-on conditions as programmed. However, you may change them if you wish. To do this, proceed as follows:

1. Set up the power supply to the state you want when it is turned on.

2. Store that state to location 0.
3. Turn off the power supply.
4. Hold in the **8** key and turn the power supply back on. The display indicates **RCL 0 PWR-ON** to verify that the power supply has configured its turn-on state to that stored in location 0.
5. From now on the supply will always turn on to the state defined in location 0.

Whenever you wish, you can return the power supply to the original factory reset state. To do this, simply hold down the **9** key when you turn on the supply. The display indicates **RST PWR-ON** to verify that the power supply has configured its turn-on state to the original reset state. From now on it will continue to turn on in that state.

Calibration

Introduction

The power supply may be calibrated from the front panel. The procedures given here apply to all models.

Important These instructions do not include verification procedures. If you require verification as part of your calibration procedure, refer to the appropriate service manual (see Table 1-3 in Chapter 1).

Equipment

The equipment listed in Table A-1, or equivalent, is required for calibration.

Table A-1. Equipment Required for Calibration

Equipment	Characteristics	Recommended Model
Voltmeter	D-c accuracy 0.005%, 6 digits	Agilent 3456A or 3458A
Shunt Resistor		
Agilent 6541A	0.01 Ω , 0.04%, 100 A, 100 W	Guildline 9230/100
Agilent 6542A, 43A, 44A, 45A	0.1 Ω , 0.04%, 15 A, 100 W	Guildline 9230/15
Agilent 6551A, 52A	0.01 Ω , 0.04%, 100 A, 100 W	Guildline 9230/100
Agilent 6553A, 54A, 55A	0.1 Ω , 0.04%, 15 A, 100 W	Guildline 9230/15
Agilent 6571A	0.001 Ω , 0.04%, 300 A, 100 W	Guildline 9230/300
Agilent 6572A, 73A, 74A, 75A	0.01 Ω , 0.04%, 100 A, 100 W	Guildline 9230/100

General Procedure

WARNING

Because the power supply output must be enabled during calibration, voltages or currents hazardous to personnel and/or dangerous to equipment can appear at the output terminals.

Parameters Calibrated

You can calibrate the voltage output and readback, the current output, and the OVP trip function. The normal procedure is to calibrate voltage first, then current. However, you do not have to do a complete calibration each time. If required, you may calibrate only the voltage or the current and then proceed to “Saving the Calibration Constants”.

If you want to calibrate the OVP trip function, the power supply will do it automatically via firmware and store the OV calibration constant. *The voltage output must be in calibration before the OV trip voltage is calibrated.*

Equipment Connections

For voltage calibration:

- Disconnect all loads from the power supply.
- Connect the supply for local sensing (see Figure 4-1 or Figure 4-2).
- Connect a DVM across the output terminals.

For current calibration:

- Disconnect all loads from the power supply.
- Connect the appropriate shunt resistor across the output terminals (see Table A-1).
- Connect a DVM across the sense terminals of the shunt resistor.

For OVP Calibration

- None (The firmware performs the calibration based on the voltage calibration constants.)

Note

You can exit the calibration procedure at any time without changing the existing calibration constants. To do this, press **Cal Disable**.

Performing The Calibration

Seven shifted keys and the Entry keypad are used for calibration functions (See “Chapter 5 - Front Panel Operation” for an explanation of shifted keys and the keypad). The following procedures assume you understand how to operate the front panel keys and that the test equipment is connected.

Entering the Calibration Values

Use the procedure in Table A-2 for entering new calibration values.

Saving the Calibration Constants



Storing the calibration constants overwrites the existing ones in nonvolatile memory. If you are not absolutely sure that you want to store the new constants, omit this step. The power supply calibration constants then will remain unchanged.

To replace any existing calibration constants with ones you have just entered, press **Cal Save**. CAL SAVED then appears on the display.

Changing the Calibration Password

You can change the password only when the module is in the calibration mode (which requires you to know the present password). When in this mode, proceed as follows:

1. Press **Pass**.
2. In response to the prompt, enter the new password. It can be up to 6 integers or 6 integers and a decimal point. If you enter more than the permitted number of integers, the extra ones will be ignored.
3. **AGAIN** will appear on the display. Enter the new password a second time.
4. When **OK** is displayed, you have changed the password. You do not have to save it. Press **Enter** to return to the meter mode.

Table A-2. Typical Calibration Procedure

Action	Display Response
Enabling the Calibration Mode	
1. Begin calibration by pressing Cal Enable .	PASWD ¹
2. Enter calibration password from Entry keypad. If password is correct the Cal annunciator will come on. If password is incorrect, an error occurs. ²	PASSWD ERROR
Note: The initial (factory-default) password is the model number of the power supply, but it can be changed (see “Changing the Password”).	
Entering Voltage Calibration Values	
1. Make certain the DVM is the only load on the power supply.	(Meter mode)
2. Select the first calibration point by pressing Vcal .	VRDG1
If the power supply is not in CV mode, an error occurs.	WRONG MODE
3. Read the DVM and use the Entry keypad to enter the first voltage value.	(Meter mode)
4. Select the second calibration point by pressing Vcal again.	VRDG2
5. Read the DVM and use the Entry keypad to enter the second voltage value.	(Meter mode)
Note: If one of the entered values is not within acceptable range, an error occurs. <i>The power supply is now holding the new voltage calibration constants in RAM.</i>	CAL ERROR
Calibrating the OVP Trip Point	
1. Make certain the voltage has been calibrated and there is no load on the power supply.	(Meter mode)
2. Select OVP calibration by pressing OVCAL .	OVCAL
3. Wait for the power supply to compute the OVP calibration constant. If the supply goes unregulated or into CC mode during OVP calibration, an error occurs. If the computed constant is out of acceptable range, an error occurs.	CAL COMPLETE NOT CV MODE DOES NOT CAL
<i>The power supply is now holding the new OVP calibration constant in RAM.</i>	
Entering Current Calibration Values	
1. Make certain appropriate shunt resistor (see Table A-1) is the only load on the power supply.	(Meter mode)
2. Select the first calibration point by pressing Ical .	IRDG1
If the power supply is not in CC mode, an error occurs.	WRONG MODE
3. Read DVM and compute the first current value (DVM reading divided by shunt resistance). (Wait for DVM reading to stabilize).	(Meter mode)
4. Use Entry keypad to enter the first current value.	IRDG2
5. Select second calibration point by pressing Ical again.	(Meter mode)
6. Read DVM and compute the second current value (DVM reading divided by shunt resistance). (Wait for DVM reading to stabilize)	(Meter mode)
7. Use Entry keypad to enter the second current value.	(Meter mode)
Note: If one of the entered values is not within acceptable range, an error occurs.	CAL ERROR
<i>The power supply is now holding the new current calibration constants in RAM.</i>	
¹ If CAL DENIED appears, then an internal jumper has been set to prevent the calibration from being changed. (See the <i>Service Manual</i> .) ² If the active password is lost, the calibration function can be recovered by moving an internal jumper that defeats password protection. However, this also will change all calibration constants to their factory-default values. (For more information, see the <i>Service Manual</i> .)	

Note If you want **Cal Enable** to operate without requiring any password, change the password to **0** (zero).

Disabling the Calibration Mode

To disable the calibration mode, press **Cal Disable**. The display will return to the meter mode with the **Cal** annunciator off. If you shut off the power supply with calibration enabled, it will be disabled when you turn it back on.

Calibration Error Messages

The following error messages may appear during calibration:

Table A-3. Calibration Error Messages

CAL ERROR	An entered value is not within acceptable range.
DOES NOT CAL	Computed calibration constant is out of range.
PASSWD ERROR	You entered an incorrect password.
WRONG MODE	The power supply is not in CV or CC mode, as required.

Line Voltage Conversion

Series 654xA and 655xA Power Supplies

WARNING

Hazardous voltage can remain inside the power supply even after it has been turned off. This procedure should be done only by qualified electronics personnel.

Provisions for converting the operating line voltage are provided inside the power supply. These provisions are:

- Series 654xA supplies: voltage select switches.
- Series 655xA supplies: voltage select jumpers.

You must also *change the power fuse* to correspond to the new line voltage setting. If you need a different power cord, contact your nearest Agilent Sales and Support Office.

Proceed as follows:

1. Turn off the ac power and disconnect the power cord.
2. Remove the four screws securing the carrying straps and dustcover.
3. Slide the dustcover back far enough to expose the line select switches (see Figure B-1) or the line select jumpers (see Figure B-2).
4. On a Series 654xA supply, move the line select switches to the positions corresponding to the desired voltage (see Figure B-1).
5. On a Series 655xA supply, move the line select jumpers to the positions corresponding to the desired voltage (see Figure B-2).

To disconnect it from the transformer tab, pull the wire straight up. Do not wiggle the wire from side-to-side as this can damage the tab.

6. Replace the top cover and secure the carrying straps.
7. Change the line fuse (on the rear panel) to the proper value for the new line voltage setting (see Table 1-3 in Chapter 1).

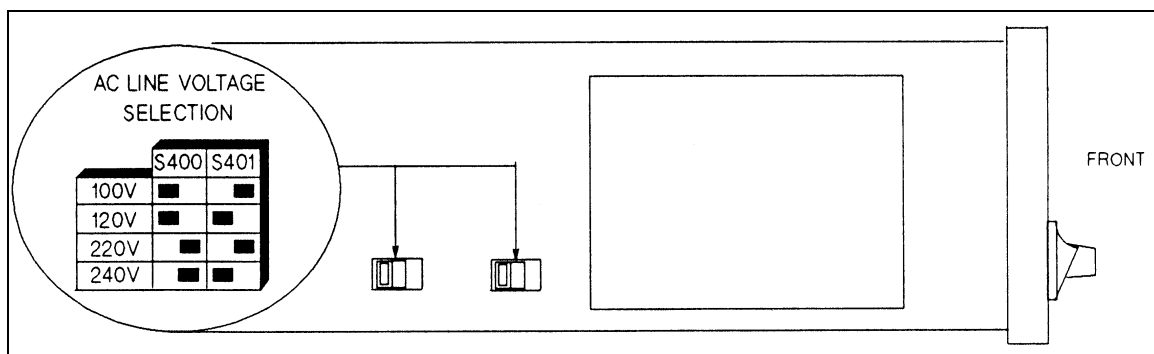

Figure B-1. Series 654xA Line Select Switches

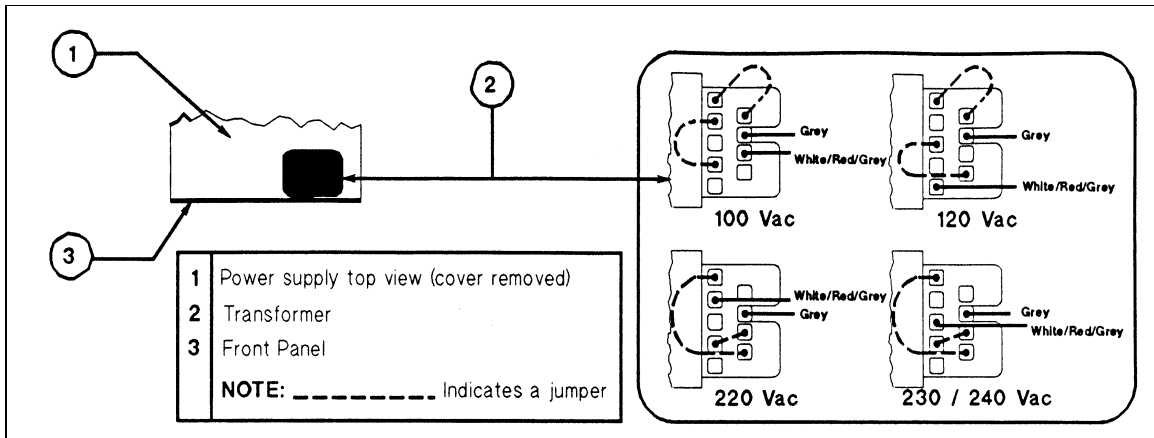

Figure B-2. Series 655xA Line Select Jumpers

Series 657xA Power Supplies

WARNING

Hazardous voltage can remain inside the power supply even after it has been turned off. This procedure should be done only by qualified electronics personnel.

Provisions for converting the operating line voltage are provided inside the power supply. .
These provisions are:

1. Turn off the ac power and disconnect the power cord from the power source.
2. Remove the four screws securing the carrying straps and dustcover.
3. Spread the bottom rear of the dustcover and pull it back to disengage it from the front panel.
4. Slide the dustcover back far enough to expose the line select switch (see Figure B-3).
5. Observe the input rail LED under the RFI shield. **If the LED is on, there is still hazardous voltage inside the supply.** Wait until the LED goes out (this may take several minutes) before proceeding.
6. Connect a dc voltmeter across test points TP1 and TP2. (It may be necessary to remove the RFI shield in order to reach these test points. The shield is secured by four screws on each side.) When the voltmeter indicates 60 volts or less, it is safe to work inside the power supply.
7. Locate the line selector switch and slide it to the desired position.
8. If you removed it in step 6, be sure to replace the RFI shield.
9. Replace the dustcover.

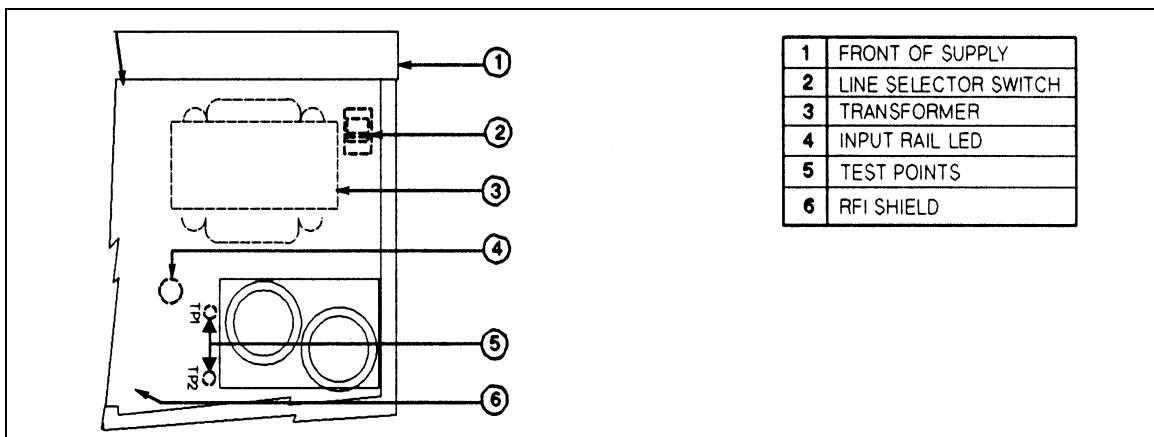



Figure B-3. Series 657xA Line Select Switch

Index







A

airflow	27
ampere capacity	42
analog	
connector	40, 42
connector wiring	41, 42
port	13, 41
programming	13, 40, 50, 51, 57, 58, 59
programming frequency	51
programming slew rate	51
programming voltage isolation	51
annunciators	
Addr	54
Cal	54, 64
CC	12, 54
CV	12, 54
Dis	32, 33, 54
Err	54
OCP	54
Prot	33, 54, 58, 59
Rmt	56
Shift	35, 54
SRQ	54
Unr	54, 60

B

backspace key 	34, 55, 57
---	------------

C

 key	64, 66
 key	65, 66
 key	64
calibration password	37, 64
capacitive loads	43
CC mode	13, 43, 55, 57, 58
checkout	
output	34
power-on	32
checksum error	37
 key	55
Common P return	41, 50, 51
CURRENT control	12, 32, 55
 key	55
 ,  keys	34, 55, 58
CV mode	13, 43, 55, 57, 58

D

default state (see factory-reset state)	
downprogramming	13, 50, 56

E

EEPROM	37
Enter key	55
Error key	54
errors	37
error messages	
calibration	66
NO GPIB	54
OL	38
OUT OF RANGE	56, 57
power-on	37
runtime	38
selftest	37
exhaust fan	28
external voltage control	41, 49

F

factory-reset state	61
front panel	
controls and indicators	12, 54
programming	13, 32, 33, 56, 57, 58, 59
fuse, line	25, 27, 28, 31, 35, 36

G

ground	
chassis	42, 49
earth	11, 29, 42
safety	42

H

hardware	25, 27
----------------	--------

I

Ical key	65
IM output	41
impedance	
output	19, 20, 24
programming source	50
inductive loads	43
initial conditions	56

IP input	41, 50
±IP differential input	41
isolation	42, 51

J

jumpers	
calibration	65
line voltage selection	68
local sense	40

L

load	
capacitance	43
electronic	59
impedance	13
inductance	43
isolation	51
line	13
multiple	44
Local key	54
local sense switch (see switch, sense)	
local sensing	31, 44
±LS terminals	31, 44, 45

M

manual change sheet	27
manual, instruction	11, 25

N

NO GPIB message	54
-----------------------	----

O

OC	12, 55, 59
OCP	48, 59
OCP key, 5-2, 5-7	
±OL	38
OT	12, 55
output	
characteristic	13, 18, 23, 56
impedance	19, 20, 24, 44
isolation	42
noise	46
oscillations	46, 47, 50
rating	12, 46
ringing	43
stability	43, 46

Output on/off key.....	34, 55, 60
OV	12, 33, 55, 58
overcurrent protection (see OCP)	
overvoltage protection (see OVP)	
OV key.....	55
OVCal key.....	65
OVP	
and battery charging	51
and output capacitance	51
and remote sensing	51
clearing.....	59
crowbar.....	48, 49
programming	58
protection diodes	48
SCR	49, 59

P

Pass key.....	64
power cord.....	11, 27, 29
power receptacle.....	11
power options	11, 16, 21
Protect key.....	34, 55, 58, 59
Prot Clear key.....	55, 59
PWR ON INIT message	32

R

rack mount kit.....	11, 27
Recall key.....	54
recalling states	45, 60
remote sensing	45, 51
remote sense switch (see switch, sense)	
resistor, shunt (see shunt, calibration)	
reverse voltage.....	49
RFI	
shield	36
suppression.....	17, 23
ringing, output, 4-5	
RPG control (see CURRENT and VOLTAGE control)	
RCL PWR-ON message	61
RST PWR-ON message.....	61

S

±S inputs	31, 41, 44, 45
safety class	11
safety compliance	17, 23
safety cover	
output	25, 39
power cord	29
safety warning	11, 36
Save key	54, 60
saving states	35, 60
sense leads (see remote sensing)	
serial number	11
service manual	11, 25, 65
shift key <input type="checkbox"/>	34, 53, 54, 56
shunt, calibration	63
slide mount, rack	12
specifications	14, 21
supplemental characteristics	15, 22
supplies in auto-parallel	47, 48
supplies in series	49
support rails	27
switch	
line voltage	67, 68
sense	31, 40, 44, 45

T

turn-on state	
factory reset	61
stored location 0	60

U

unregulated output	60
--------------------------	----

V

Vcal key	65
verification tests	31, 63
VOLTAGE control	12, 32, 54, 57
Voltage key	55
↑Voltage ↓Voltage keys	33, 55, 57, 58
VP input	41, 50

W

wire size	41
-----------------	----

Agilent Sales and Support Office

For more information about Agilent Technologies test and measurement products, applications, services, and for a current sales office listing, visit our web site: <http://www.agilent.com/find/tmdir>

You can also contact one of the following centers and ask for a test and measurement sales representative.

United States:

Agilent Technologies
Test and Measurement Call Center
P.O. Box 4026
Englewood, CO 80155-4026
(tel) 1 800 452 4844

Latin America:

Agilent Technologies
Latin American Region Headquarters
5200 Blue Lagoon Drive, Suite #950
Miami, Florida 33126
U.S.A.
(tel) (305) 267 4245
(fax) (305) 267 4286

Canada:

Agilent Technologies Canada Inc.
5150 Spectrum Way
Mississauga, Ontario
L4W 5G1
(tel) 1 877 894 4414

Australia/New Zealand:

Agilent Technologies Australia Pty Ltd
347 Burwood Highway
Forest Hill, Victoria 3131
(tel) 1-800 629 485 (Australia)
(fax) (61 3) 9272 0749
(tel) 0 800 738 378 (New Zealand)
(fax) (64 4) 802 6881

Europe:

Agilent Technologies
Test & Measurement European Marketing Organisation
P.O. Box 999
1180 AZ Amstelveen
The Netherlands
(tel) (31 20) 547 9999

Asia Pacific:

Agilent Technologies
24/F, Cityplaza One, 1111 King's Road,
Taikoo Shing, Hong Kong
tel: (852)-3197-7777
fax: (852)-2506-9284

Japan:

Agilent Technologies Japan Ltd.
Measurement Assistance Center
9-1, Takakura-Cho, Hachioji-Shi,
Tokyo 192-8510, Japan
(tel) (81) 426 56 7832
(fax) (81) 426 56 7840
Technical data is subject to change.

Manual Updates

The following updates have been made to this manual since the print revision indicated on the title page.

4/01/00

All references to HP have been changed to Agilent.
All references to HP-IB have been changed to GPIB.

11/06/02

The declarations pages have been updated.

3/11/04

The ac input ratings and fuse information for Series 654xA has been updated as per IEC 61010-1 requirements throughout the manual. The Declarations of Conformity for all models have been updated.

7/16/04

A note has been added to the specifications on page 14.
The Declarations of Conformity for all models have been updated.

5/04/09

A URL has been added to the declarations pages to obtain the latest declaration of conformity.
Option 841 has been removed from page 11 as it is no longer available.
The RF field annotation note has been removed from Table 1-1a.