

Agilent Technologies
Low-Profile
Modular Power System
Series N6700

User's Guide

Legal Notices

© Agilent Technologies, Inc. 2006-2012

No part of this document may be photocopied, reproduced, or translated to another language without the prior agreement and written consent of Agilent Technologies, Inc. as governed by United States and international copyright laws.

Warranty

The material contained in this document is provided “as is,” and is subject to being changed, without notice, in future editions. Further, to the maximum extent permitted by applicable law, Agilent disclaims all warranties, either express or implied, with regard to this manual and any information contained herein, including but not limited to the implied warranties of merchantability and fitness for a particular purpose. Agilent shall not be liable for errors or for incidental or consequential damages in connection with the furnishing, use, or performance of this document or of any information contained herein. Should Agilent and the user have a separate written agreement with warranty terms covering the material in this document that conflict with these terms, the warranty terms in the separate agreement shall control.

Manual Editions

Manual Part Number: 5969-2937
Seventh Edition, June, 2012
Printed in Malaysia.

Reprints of this manual containing minor corrections and updates may have the same printing date. Revised editions are identified by a new printing date.

Declaration of Conformity

Declarations of Conformity for this product and for other Agilent products may be downloaded from the Web. Go to <http://regulations.corporate.agilent.com> and click on “Declarations of Conformity.” You can then search by product number to find the latest Declaration of Conformity

Waste Electrical and Electronic Equipment (WEEE) Directive 2002/96/EC

This product complies with the WEEE Directive 2002/96/EC marketing requirement. The affixed product label (see below) indicates that you must not discard this electrical/electronic product in domestic household waste.

Product Category: With reference to the equipment types in the WEEE directive Annex 1, this product is classified as “Monitoring and Control instrumentation” product.

Do not dispose in domestic household waste.

To return unwanted products, contact our local Agilent office, or see www.agilent.com/environment/product for more information.



Certification

Agilent Technologies certifies that this product met its published specifications at time of shipment from the factory. Agilent Technologies further certifies that its calibration measurements are traceable to the United States National Institute of Standards and Technology, to the extent allowed by the Institute’s calibration facility, and to the calibration facilities of other International Standards Organization members.

Exclusive Remedies

THE REMEDIES PROVIDED HEREIN ARE THE CUSTOMER’S SOLE AND EXCLUSIVE REMEDIES. AGILENT TECHNOLOGIES SHALL NOT BE LIABLE FOR ANY DIRECT, INDIRECT, SPECIAL, INCIDENTAL, OR CONSEQUENTIAL DAMAGES, WHETHER BASED ON CONTRACT, TORT, OR ANY OTHER LEGAL THEORY.

Assistance

This product comes with the standard product warranty. Warranty options, extended support contacts, product maintenance agreements and customer assistance agreements are also available. Contact your nearest Agilent Technologies Sales and Service office for further information on Agilent Technologies’ full line of Support Programs.

Technologies Licenses

The hardware and or software described in this document are furnished under a license and may be used or copied only in accordance with the terms of such license.

U.S. Government Restricted Rights

Software and technical data rights granted to the federal government include only those rights customarily provided to end user customers. Agilent provides this customary commercial license in Software and technical data pursuant to FAR 12.211 (Technical Data) and 12.212 (Computer Software) and, for the Department of Defense, DFARS 252.227-7015 (Technical Data – Commercial Items) and DFARS 227.7202-3 (Rights in Commercial Computer Software or Computer Software Documentation).

Trademarks

Microsoft and Windows are U.S. registered trademarks of Microsoft Corporation.

Safety Notices

The following general safety precautions must be observed during all phases of operation of this instrument. Failure to comply with these precautions or with specific warnings or instructions elsewhere in this manual violates safety standards of design, manufacture, and intended use of the instrument. Agilent Technologies assumes no liability for the customer's failure to comply with these requirements.

General

Do not use this product in any manner not specified by the manufacturer. The protective features of this product may be impaired if it is used in a manner not specified in the operation instructions.

Before Applying Power

Verify that all safety precautions are taken. Make all connections to the unit before applying power. Note the instrument's external markings described under "Safety Symbols"

Ground the Instrument

This product is a Safety Class 1 instrument (provided with a protective earth terminal). To minimize shock hazard, the instrument chassis and cover must be connected to an electrical ground. The instrument must be connected to the AC power mains through a grounded power cable, with the ground wire firmly connected to an electrical ground (safety ground) at the power outlet. Any interruption of the protective (grounding) conductor or disconnection of the protective earth terminal will cause a potential shock hazard that could result in personal injury.

Fuses

The instrument contains an internal fuse, which is not customer accessible.

Do Not Operate in an Explosive Atmosphere

Do not operate the instrument in the presence of flammable gases or fumes.

Do Not Remove the Instrument Cover

Only qualified, service-trained personnel who are aware of the hazards involved should remove instrument covers. Always disconnect the power cable and any external circuits before removing the instrument cover.

Do Not Modify the Instrument

Do not install substitute parts or perform any unauthorized modification to the product. Return the product to an Agilent Sales and Service Office for service and repair to ensure that safety features are maintained.

In Case of Damage

Instruments that appear damaged or defective should be made inoperative and secured against unintended operation until they can be repaired by qualified service personnel.



















CAUTION

A **CAUTION** notice denotes a hazard. It calls attention to an operating procedure, practice, or the like that, if not correctly performed or adhered to, could result in damage to the product or loss of important data. Do not proceed beyond a **CAUTION** notice until the indicated conditions are fully understood and met.

WARNING

A **WARNING** notice denotes a hazard. It calls attention to an operating procedure, practice, or the like that, if not correctly performed or adhered to, could result in personal injury or death. Do not proceed beyond a **WARNING** notice until the indicated conditions are fully understood and met.

Safety Symbols

	Direct current
	Alternating current
	Both direct and alternating current
	Three phase alternating current
	Earth (ground) terminal
	Protective earth ground terminal.
	Frame or chassis terminal
	Terminal is at earth potential.
	Neutral conductor on permanently installed equipment
	Line conductor on permanently installed equipment.
	On supply
	Off supply
	Standby supply. Unit is not completely disconnected from AC mains when switch is off
	In position of a bi-stable push switch
	Out position of a bi-stable push switch
	Caution, risk of electric shock
	Caution, hot surface
	Caution, refer to accompanying description

In this Book

Specific chapters in this manual contain the following information:

- Quick Reference – Chapter 1 is a quick reference section that helps you quickly become familiar with your Agilent N6700 Modular Power System. It describes the differences between the various modules in the power system.
- Installation – Chapter 2 describes how to install your power system. It describes how to connect various loads to the output. It discusses remote sensing as well as parallel and series operation.
- Getting Started – Chapter 3 describes how to set the voltage, current, over-voltage protection, and turn on the output. It also describes how to configure the remote interface.
- Operating the Power System – Chapter 4 describes how to use the advanced features of the power system using the front panel menus and the corresponding SCPI commands.
- Specifications – Appendix A describes the mainframe characteristics.
- Using the Digital Port – Appendix B describes how to configure and use the digital port on the back of the instrument.
- Power Allocation – Appendix C describes the power allocation function, which applies to power system in which the combined ratings of the power modules exceed the power rating of the mainframe.
- Output On/Off Synchronization – Appendix D discusses output on/off synchronization, which lets you accurately synchronize output turn-on sequences across multiple mainframes.
- Source Operating Modes – Appendix E discusses operating mode information for all power modules.

For complete details on the SCPI (Standard Commands for Programmable Instruments) commands, refer to the N6700 Programmer's Reference Help file included on the Agilent N6700 Product Reference CD. This CD-ROM is shipped along with your instrument.

NOTE

You can contact Agilent Technologies at one of the following telephone numbers for warranty, service, or technical support information.

In the United States: (800) 829-4444

In Europe: 31 20 547 2111

In Japan: 0120-421-345

Or use our Web link for information on contacting Agilent in your country or specific location: www.agilent.com/find/assist

Or contact your Agilent Technologies Representative.

Contents

1 – Quick Reference	7
The Agilent N6700 Modular Power System – At a Glance.....	8
The Front Panel – At a Glance.....	11
The Rear Panel – At a Glance.....	11
Front Panel Display – At a Glance	12
Front Panel Keys – At a Glance.....	13
Front Panel Menu Reference	14
SCPI Command Summary.....	16
2 – Installation	23
General Information.....	24
Inspecting the Unit	25
 Installing the Unit.....	26
Connecting the Line Cord	30
Connecting the Outputs	31
Remote Sense Connections.....	36
Parallel Connections.....	38
Series Connections.....	40
Additional Load Considerations.....	42
Connecting the Auxiliary Voltage Measurement Input.....	44
3 – Getting Started	45
Turning the Unit On	46
Selecting an Output Channel	46
Entering an Output Voltage Setting	46
Entering a Current Limit Setting	47
Enabling the Output.....	47
Using the Front Panel Menu	48
Connecting to the Interfaces	50
Communicating Over the LAN	57
Securing the Interfaces.....	59
4 – Operating the Power System	61
Programming the Output	62
Synchronizing Output Steps.....	68
Programming Output Lists.....	72
Making Measurements	77
Using the Digitizer.....	79
Using the Protection Functions.....	87

External Data Logging	91
System-Related Operations.....	95
A – Specifications.....	99
Agilent N6700B, N6701A, N6702A MPS Mainframes.....	100
B – Using the Digital Port.....	103
Digital Control Port	104
Configuring the Digital Control Port.....	105
C – Power Allocation	109
Power Limit Operation	110
Module Power Allocation.....	111
D – Output On/Off Synchronization	113
Synchronizing Output Turn-on Delays.....	114
Synchronizing Multiple Mainframes.....	117
Operation	118
E – Source Operating Modes	119
Single Quadrant Operation	120
Agilent N678xA Multi-Quadrant Operation	122

Updates

This manual describes firmware revision D.01.09 and up. Go to <http://www.agilent.com/find/N6700firmware> if you need to download this or any later versions of the firmware. Information on how to install the firmware is available on the web site.

Refer to “Instrument Identification” in chapter 4 to view the firmware version that is currently installed in your mainframe.

Updated versions of this manual are also posted on the web. Go to <http://www.agilent.com/find/N6700> to get the latest version of the manual.

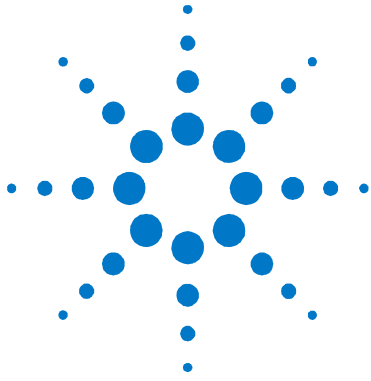

1

Quick Reference

The Agilent N6700 Modular Power System – At a Glance	8
The Front Panel – At a Glance	11
The Rear Panel – At a Glance	11
Front Panel Display – At a Glance	12
Front Panel Keys – At a Glance	13
Front Panel Menu Reference	14
SCPI Command Summary	16

This chapter concisely describes the operation of the Agilent N6700 Modular Power System (MPS).

This chapter does not describe every operating feature in detail. It is simply a quick reference guide to quickly become familiar with the essential operating features of the power system.

For complete details on the SCPI (Standard Commands for Programmable Instruments) commands, refer to the Programmer's Reference Help file included on the Agilent N6700 Product Reference CD. This CD-ROM is shipped along with your instrument.

NOTE

Unless otherwise noted, the Agilent N6700 Modular Power System will also be referred to as "MPS" and "power system" throughout this manual.

The Agilent N6700 Modular Power System – At a Glance

The Agilent N6700 Modular Power System is a configurable, one rack-unit (1U) platform that lets you mix and match power modules to create a power system optimized for your test system requirements.

Agilent N6700–N6702 MPS mainframes are available in power levels of 400 W, 600 W, and 1,200 W. Up to four power modules can be installed in each mainframe. Power modules come in power levels of 20 W through 500 W, have various voltage and current combinations, and provide the following performance features:

- The N673xB, N674xB, and N677xA DC Power Modules provide programmable voltage and current, measurement, and protection features, making these economical models suitable for powering the device-under-test or system resources such as fixture controls.
- The N675xA High-Performance, Autoranging DC Power Modules provide low noise, high accuracy, fast programming times, and advanced programming and measurement capabilities to speed test throughput.
- The N676xA Precision DC Power Modules provide precise control and measurements in the milli- and micro-ampere region with the ability to simultaneously digitize voltage and current and capture those measurements into an oscilloscope-like data buffer.
- The N678xA Source/Measure Units (SMU) have a multiple-quadrant power mesh with separate voltage and current priority source modes. These models are optimized for applications such as battery drain analysis and functional testing.
- The N6783A Application-Specific DC Power Modules are two-quadrant low-wattage models specifically designed for battery charging/discharging and mobile communications applications.

The output and system features are described in the following sections. Not all output features are available on every power module. The “Model Differences” section describes the features that apply only to specific power modules.

Output Features

Programmable voltage and current	Full programming capability is provided for the entire range of output voltage and current. Outputs can operate as either constant voltage (CV) or constant current (CC) sources.
Low output noise	Available on Agilent N676xA and N675xA power modules. Output noise is <4.5 mV peak-to-peak, which is comparable to linear supplies.
Fast up/down programming	Available on Agilent N675xA, N676xA, and N678xA SMU power modules. ≤1.5 millisecond response time from 10% to 90% of the output rating.
Fast transient response	Available on Agilent N675xA, N676xA, and N678xA SMU power modules. Transient response is less than 100 μs.

Output autoranging capability	Available on Agilent N676xA and N675xA power modules. Autoranging supplies the maximum rated power over a continuous range of voltage and current settings.
Output On/Off sequencing	A turn-on/turn-off delay capability for each output allows output on/off sequencing.
Remote voltage sensing	Two remote sensing terminals are provided for each output. When shipped, the remote sense jumpers are included in a separate bag. See Chapter 2.
Output protection	Each output has over-voltage, over-current, and over-temperature protection. Over-voltage and over-current protection are programmable.
Multiple-Quadrant operation	Available on Agilent N678xA SMU and N6783A power modules. 2- and 4-quadrant operation provides source and sink output capability.

Measurement Features

Multiple-output/Single-output meter display	Switch between a 4-output summary view and a 1-output detailed view of power supply information. All power modules display real-time output voltage and current measurements as well as status information.
Seamless measurement autoranging	Available on Agilent N6781A and N6782A SMU power modules. Output measurements seamlessly autorange between ranges – however, the 10 μ A current range must be selected manually.
Microampere current measurements	Available on Agilent N6761A, N6762A, and N678xA SMU power modules. Current measurement can be made as low as 1 μ A in the 10 μ A range.
Fast digitizing	Available on Agilent N678xA SMU power modules. 5.12 μ s/sample for one parameter; 10.24 μ s/sample for two parameters.

System Features

Choice of three interfaces	GPIB (IEEE-488), LAN, and USB remote programming interfaces are built in.
Built-in Web server	A built-in Web server lets you control the instrument directly from an internet browser on your computer.
SCPI language	The instrument is compatible with the Standard Commands for Programmable Instruments (SCPI).
Front panel I/O setup	Menus let you set up GPIB and LAN parameters from the front panel.
Real-time status information	The front panel indicates the status of each output. It also indicates when a protection shut-down has occurred.
Module identification	Each module has identifying data stored in non-volatile memory. Information includes model number, serial number, and options.
Universal AC input	Mainframes have universal input voltage capability with active power factor correction.

Model Differences

Feature (● = available)	DC Power			High-Performance	Precision
	N673xB, N674xB, N677xA			N675xA	N676xA
50 W output rating	N6731B – N6736B			N6751A	N6761A
100 W output rating	N6741B – N6746B			N6752A	N6762A
300 W output rating	N6773A – N6777A			N6753A, N6754A	N6763A, N6764A
500 W output rating				N6755A, N6756A	N6765A, N6766A
Output disconnect relays	Option 761			Option 761	Option 761
Output disconnect/polarity reversal relays ^{NOTE 1}	Option 760			Option 760	Option 760
Autoranging output capability				●	●
Voltage or current turn-on priority					N6761A, N6762A
Precision voltage and current measurements					●
Low voltage and current output ranges					N6761A, N6762A
Low voltage and current measurement ranges					●
200 microampere measurement range ^{NOTE 2}					Option 2UA
Simultaneous voltage and current measurements					●
Output list capability (Test Extensions) ^{NOTE 3}	Option 054			Option 054	●
Array readback capability (Test Extensions) ^{NOTE 3}	Option 054			Option 054	●
Programmable sample rate (Test Extensions) ^{NOTE 3}	Option 054			Option 054	●
Double-wide (occupies 2 channel locations)				N6753A – N6756A	N6763A – N6766A
Feature (● = available)	Source/Measure Units (SMU)			Application-Specific	
	N6781A	N6782A	N6784A	N6783A-BAT	N6783A-MFG
Output rating	20 W	20 W	20 W	24 W	18 W
2-quadrant operation	●	●		●	●
4-quadrant operation			●		
Auxiliary voltage measurement input	●				
Output disconnect relays	●	●	●	Option 761	Option 761
Negative voltage protection	●	●	●	●	●
Voltage or current priority mode	●	●	●		
Programmable output resistance	●				
600 mV output range	●	●	●		
300 mA output range	●	●			
100 mA, 10 mA output ranges			●		
1 V, 100 mV measurement ranges	●	●	●		
100 mA, 1 mA, 10 μA measurement ranges	●	●	●		
150 mA measurement range				●	●
Simultaneous voltage and current measurements	●	●	●		
Seamless measurement autoranging	●	●			
Output list capability ^{NOTE 3, 4}	●	●	●	●	●
Array readback capability ^{NOTE 3}	●	●	●	●	●
Programmable sample rate ^{NOTE 3}	●	●	●	●	●

¹ Output current is limited to 10A max. on Models N6742B and N6773A with Option 760. Option 760 is not available on Models N6741B, N6751A, N6752A, N6761A, and N6762A.

² Option 2UA is only available on Models N6761A and N6762A. It includes Option 761.

³ Only available when using the remote interfaces; not from the front panel.

⁴ List capability is not available on the negative current output on Model N6783A

The Front Panel – At a Glance

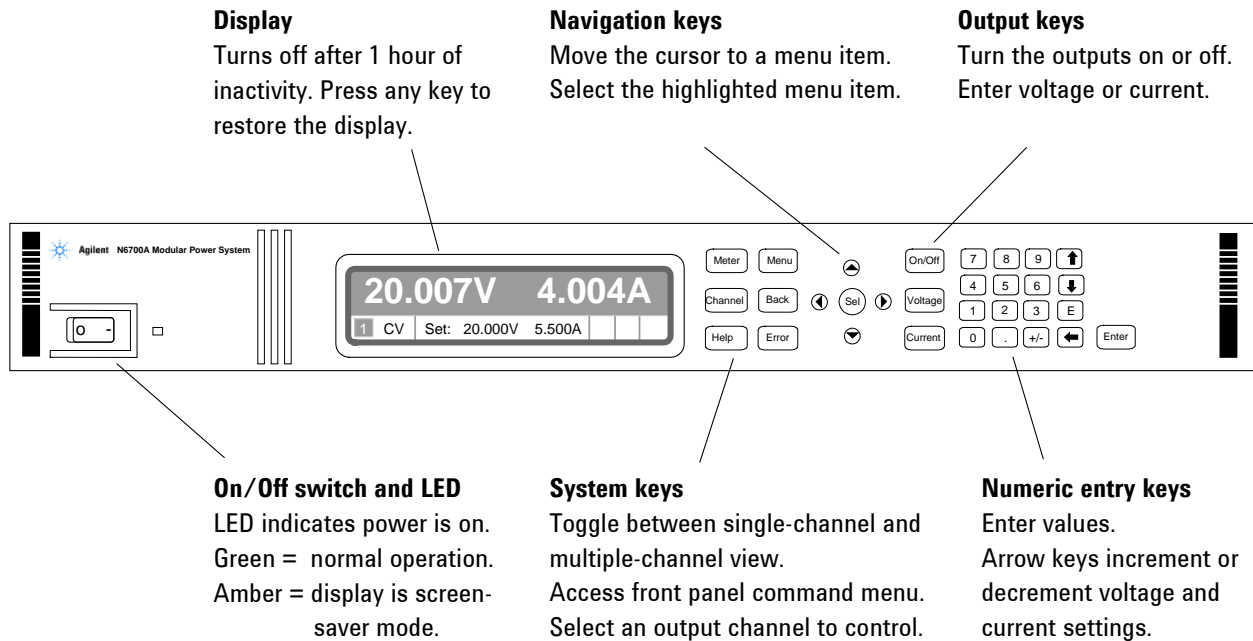

The Rear Panel – At a Glance

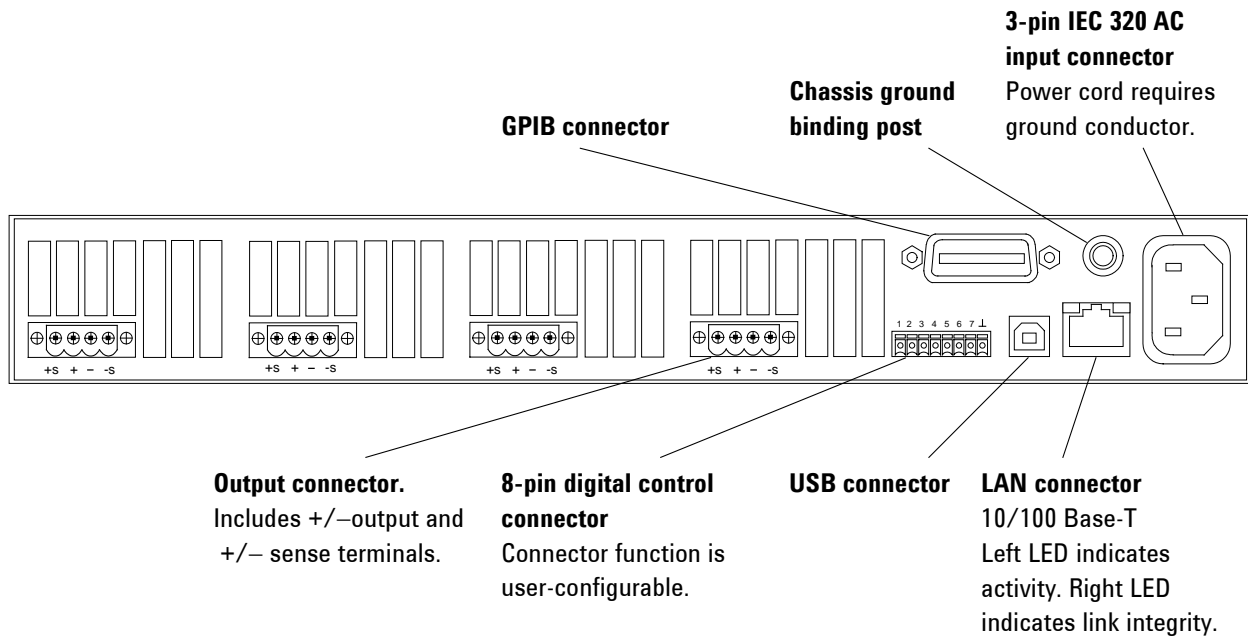

WARNING

SHOCK HAZARD The power cord provides a chassis ground through a third conductor. Be certain that your power outlet is of the three-conductor type with the correct pin connected to earth ground.

Front Panel Display – At a Glance

Single-channel view

Press the **Meter** key to toggle between views

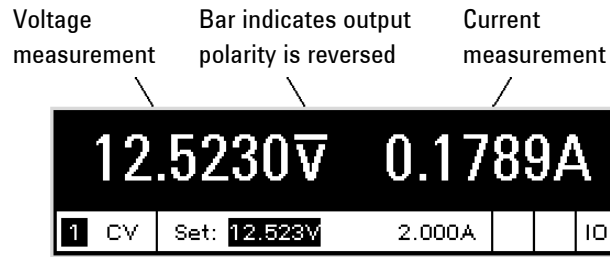

Operating status (CV = constant voltage) Voltage and current settings Interface status (IO = activity on interface)

Multiple-channel view

Press the **Meter** key to toggle between views

Voltage and Current measurements

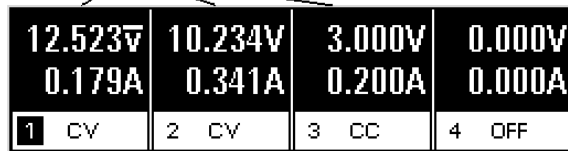

The highlighted channel is the active channel

Grouped-channel view

Refer to Chapter 4, under “System-Related Operations” for more information

Channels 2 through 4 are connected in parallel and have been configured or grouped to act as a single, higher-power channel

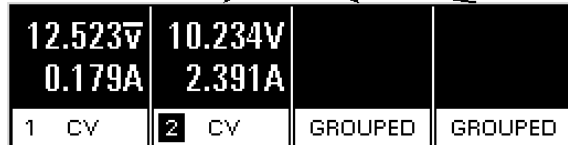

Grouped channels are addressed using the channel number of the **lowest** channel in the group

Double-wide view

Channel 2 is a double-wide power module that occupies two channel locations in the mainframe

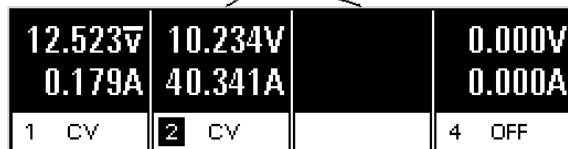

Interface status indicators

Err = an error has occurred (press Error key to display error message)
 Lan = the LAN is connected and has been configured
 IO = there is activity on one of the remote interfaces

Operating status indicators	<p>OFF = the output is off</p> <p>CV = the output is in constant voltage mode</p> <p>CC = the output is in constant current mode</p> <p>CP+ = the output is limited (or disabled) by the positive power limit</p> <p>CP- = the output is limited (or disabled) by the negative power limit</p> <p>VL+/- = the output is in positive or negative voltage limit mode</p> <p>CL+/- = the output is in positive or negative current limit mode</p> <p>OV = the output is disabled by the over-voltage protection</p> <p>OV- = the output is disabled by the negative over-voltage protection</p> <p>OC = the output is disabled by the over-current protection</p> <p>OT = the over-temperature protection has tripped</p> <p>PF = the output is disabled by a power-fail condition</p> <p>OSC = the output is disabled by the oscillation protection</p> <p>INH = the output is disabled by an external inhibit signal</p> <p>UNR = the output is unregulated</p> <p>PROT = the output is disabled by a condition from a coupled channel</p>
------------------------------------	---

Front Panel Keys – At a Glance

System keys

Meter

Menu

Meter returns the display to metering mode.

Channel

Back

Menu accesses the command menu.

Channel selects or highlights a channel to control.

Help

Error

Back backs out of a menu without activating any changes.

Help accesses information about the displayed menu control.

Error displays any error messages in the error queue.

Navigation keys



The Arrow keys let you move around in the command menus.



The Select key lets you make a selection in the command menus. It also lets you enter edit mode for numeric parameters.



Output keys

On/Off

On/Off controls the selected output (or all outputs when **All** is lit).

Voltage

This key is only active in Single- channel or Multiple-channel view.

Voltage lets you change the voltage setting of the selected channel.

Current

Current lets you change the current setting of the selected channel.

Number keys

7

8

9



The 0 through 9 keys enter numbers. The (.) key is the decimal point. The +/- key is only used to enter a minus sign.

4

5

6



The E key enters an exponent. Add the value to the right of the E.

1

2

3

E

The ← backspace key deletes digits as it backspaces over them.

0

.

+/-



Enter

The ↑ ↓ arrow keys increment or decrement the voltage or current settings. They are also used to select letters in alphabetic entry fields.

The Enter key enters a value. If you exit a field without pressing the Enter key, the value is ignored.

Front Panel Menu Reference

NOTE

Menu commands that appear grayed-out on the front panel are either not available for the power module, or are password protected.

Menu Command		Control Description		
Output	Voltage	Programs voltage setting, limits, and ranges.		
	Current	Programs current setting, limits, and ranges.		
	Mode	Programs output priority mode on Models N678xA SMU.		
	Sequence	Delay	Programs Turn-on /Turn off delay.	
		Couple	Couples output channels for output on/off synchronization.	
	Advanced	Slew	Voltage	Programs voltage slew rate.
			Current	Programs current slew rate on Models N678xA SMU.
		Power	Programs the power allocation function.	
		Pol	Lets you reverse the polarity of the output and sense terminals.	
		Resistance	Programs output resistance on Model N6781A.	
Bandwidth		Programs output voltage bandwidth on Models N678xA SMU.		
	Tmode	Programs turn-on/turn-off impedance on Models N678xA SMU.		
Measure	Range	Selects voltage and current measurement range.		
	Sweep	Specifies measurement points, time interval, and trigger offset.		
	Window	Selects measurement window: Rectangular, Hanning.		
	Input	Selects Auxiliary voltage measurements on Model N6781A.		
	Control	Lets you abort a measurement in progress.		
Transient	Mode	Selects voltage or current transient mode: Fixed, Step, List.		
	Step	Programs voltage and current step value. Enables step triggers.		
	List	Pace	Specifies Dwell or Trigger paced list.	
		Repeat	Specifies number of list repetitions, or specifies continuous list.	
		Terminate	Specifies list settings when the list terminates.	
		Config	Configures list step voltage, current, dwell, and trigger signals.	
		Reset	Aborts the list and resets all list parameters.	
	TrigSource	Specify the trigger source: Bus, Tran 1-4, Pin 1-7, Ext.		
	Control	Initiates, Triggers, or Aborts output triggers. Displays trigger state.		
Protect	OVP	Configures over-voltage protection function.		
	OCP	Configures over-current protection function.		
	Inhibit	Configures the external inhibit signal: Off, Latching, Live		
	Coupling	Disables ALL output channels when a protection fault occurs.		
	Wdog	Configures the output watchdog timer.		
	Osc	Enables/disables oscillation protection on Models N678xA SMU.		
	Clear	Clears output protection. Displays output state.		
States	Reset	Resets the instrument to its reset (*RST) state.		
	SaveRecall	Saves or recalls an instrument state.		
	PowerOn	Selects the power-on state: *RST, RCL0.		

Menu Command		Control		Description	
System	IO	LAN	ActiveSettings	Displays the LAN interface settings that are presently active.	
			Config	IP	Configures the IP addressing of the instrument.
				Name	Configures the Dynamic DNS and NetBIOS naming service.
				Domain	Configures the Domain Name.
				DNS	Configures the DNS server.
				TCP	Configures the TCP keepalive function.
		Reset	Resets the LAN interface settings to the factory-shipped state.		
		USB	Status	Displays status, speed, packets received, and packets sent.	
			Identification	USB connect string - the instrument's unique USB identifier.	
		GPIB		Selects the GPIB address.	
		DigPort	Pins<1>	Function	Specifies the pin function: DigIn, DigIO, TrigIn, TrigOut, FaultOut.
			Pins<2>	Function	Specifies the pin function: DigIn, DigIO, TrigIn, TrigOut.
			Pins<3>	Function	Specifies the pin function: DigIn, DigIO, TrigIn, TrigOut, InhibitIn.
			Pins<4-7>	Function	Specifies the pin function: DigIn, DigIO, TrigIn, TrigOut, OnC, OffC.
			Pins<1-7>	Polarity	Specifies the pin polarity: Positive, Negative
			Data		Sends/reads data from the digital I/O port
		Groups		Defines groups of output channels that are connected in parallel.	
		Preferences	Display	Contrast	Configures the display contrast.
				Saver	Configures the screen saver and wake-on I/O timer.
				View	Selects 1-channel or 4-channel view at turn-on
			Keys	Enables/disables key clicks and configures the On/Off key.	
Lock	Locks front panel keys. Enter a password to unlock the front panel.				
Admin	Login/Logout	Enter a password to access the admin functions.			
	Cal	Volt	Vprog	Calibrates High and Low voltage ranges.	
			Vlim	Calibrates voltage limit High and Low ranges	
			Vmeas	Calibrates High, Low, and Aux voltage measurement ranges.	
		Curr	Iprog	Calibrates High and Low current ranges.	
			Ilim	Calibrates current limit.	
			Imeas	Calibrates High and Low current measurement ranges.	
		Misc	CMRR	Calibrates common mode rejection ratio.	
			Dprog	Calibrates the downprogrammer.	
			Ipeak	Calibrates I peak.	
	Resistance	Calibrates output resistance High and Low ranges.			
	Date	Saves the calibration date for each channel.			
	Save	Saves the calibration data.			
	LAN	Enables/disables the LAN interface and the built-in Web server.			
	USB	Enables/disables the USB interface.			
Nvram	Resets all non-volatile RAM settings to their factory defaults.				
Password	Changes the password for the admin functions.				
About	Frame	Displays model, serial number, and firmware revisions.			
	Module	Displays model, serial number, options, voltage, current, power.			

SCPI Command Summary

Subsystem Commands

NOTE

Some [optional] commands have been included for clarity. All settings commands have a corresponding query. Not all commands apply to all models.

SCPI Command	Description
ABORt	
:ACQuire (@chanlist)	Resets the measurement trigger system to the Idle state
:ELOG (@chanlist)	Stops the external data log
:TRANsient (@chanlist)	Resets the transient trigger system to the Idle state
CALibrate	
:CURRent	
[:LEVel] <NRf>, (@channel)	Calibrates the output current programming
:LIMit	
:NEGative <NRf>, (@channel)	Calibrates the negative current limit (only on N6783A)
:POSitive <NRf>, (@channel)	Calibrates the positive current limit (only on N678xA SMU)
:MEASure <NRf>, (@channel)	Calibrates the current measurement
:PEAK (@channel)	Calibrates the peak current limit (only on N675xA, N676xA)
:DATA <NRf>	Enters the calibration value
:DATE <"date">, (@channel)	Sets the calibration date
:DPRog (@channel)	Calibrates the current downprogrammer
:LEVel P1 P2 P3	Advances to the next calibration step
:PASSword <NRf>	Sets the numeric calibration password
:RESistance 20 6, (@channel)	Calibrates the output resistance (only on N6781A)
:SAVE	Saves the new cal constants in non-volatile memory
:STATE <Bool> [, <NRf>]	Enables/disables calibration mode
:VOLTage	
[:LEVel] <NRf>, (@channel)	Calibrates the output voltage programming
:CMRR (@channel)	Calibrates common mode rejection ratio (only N675xA, N676xA)
:LIMit	
:POSitive <NRf>, (@channel)	Calibrates the positive voltage limit (only on N678xA SMU)
:MEASure <NRf>, (@channel)	Calibrates the voltage measurement
:AUXiliary (@channel)	Calibrates the auxiliary voltage measurement (only on N6781A)
DISPlay	
[:WINDow]	
:CHANnel <channel>	Selects the channel in 1-channel meter view
:VIEW METER1 METER4	Selects 1-channel or 4-channel meter view
FETCh	(Fetch commands only on N676xA, N678xA SMU and Option 054)
[:SCALar]	
:CURRent	
[:DC]? (@chanlist)	Returns the average current
:ACDC? (@chanlist)	Returns the total rms current (AC + DC)
:HIGH? (@chanlist)	Returns the high level of a current pulse
:LOW? (@chanlist)	Returns the low level of a current pulse
:MAXimum? (@chanlist)	Returns the maximum current
:MINimum? (@chanlist)	Returns the minimum current

SCPI Command	Description
FETCh[:SCALar] (continued)	
:POWer	
[:DC]? (@chanlist)	Returns the average output power
:VOLTagE	
[:DC]? (@chanlist)	Returns the average voltage
:ACDC? (@chanlist)	Returns the total rms voltage (AC + DC)
:HIGH? (@chanlist)	Returns the high level of a voltage pulse
:LOW? (@chanlist)	Returns the low level of a voltage pulse
:MAXimum? (@chanlist)	Returns the maximum voltage
:MINimum? (@chanlist)	Returns the minimum voltage
:ARRay	
:CURRent [:DC]? (@chanlist)	Returns the instantaneous output current
:POWer [:DC]? (@chanlist)	Returns the instantaneous output power
:VOLTagE [:DC]? (@chanlist)	Returns the instantaneous output voltage
:ELOG <NR1>, (@chanlist)	Returns the most recent external data log records
FORMat	
[:DATA] ASCII REAL	Returns data as ASCII or binary
:BORDER NORMAl SWAPped	Sets the byte order of the external data log data
INITiate	
[:IMMEDIATE]	(Acquire command only on N676xA, N678xA SMU and Option 054)
:ACQuire (@chanlist)	Enables the measurement system to receive triggers
:ELOG (@chanlist)	Enables external data log measurements
:TRANsient (@chanlist)	Enables the output transient system to receive triggers
:CONTInuous	
:TRANsient <Bool>, (@chanlist)	Enables/disables continuous transient triggers
MEASure	
[:SCALar]	
:CURRent	
[:DC]? (@chanlist)	Takes a measurement; returns the average current
:ACDC? (@chanlist)	Takes a measurement; returns the total rms current (AC + DC)
:HIGH? (@chanlist)	Takes a measurement; returns the high level of a current pulse
:LOW? (@chanlist)	Takes a measurement; returns the low level of a current pulse
:MAXimum? (@chanlist)	Takes a measurement; returns the maximum current
:MINimum? (@chanlist)	Takes a measurement; returns the minimum current
:POWer	
[:DC]? (@chanlist)	Takes a measurement; returns the average output power
:VOLTagE	
[:DC]? (@chanlist)	Takes a measurement; returns the average voltage
:ACDC? (@chanlist)	Takes a measurement; returns the total rms voltage (AC + DC)
:HIGH? (@chanlist)	Takes a measurement; returns the high level of a voltage pulse
:LOW? (@chanlist)	Takes a measurement; returns the low level of a voltage pulse
:MAXimum? (@chanlist)	Takes a measurement; returns the maximum voltage
:MINimum? (@chanlist)	Takes a measurement; returns the minimum voltage
:ARRay	(Array commands only on N676xA, N678xA SMU and Option 054)
:CURRent [:DC]? (@chanlist)	Takes a measurement; returns the instantaneous output current
:POWer [:DC]? (@chanlist)	Takes a measurement; returns the instantaneous output power
:VOLTagE [:DC]? (@chanlist)	Takes a measurement; returns the instantaneous output voltage

1 Quick Reference

SCPI Command	Description
OUTPut	
[:STATe] <Bool> [,NORelay], (@chanlist)	Enables/disables the specified output channel(s)
:COUPle	
[:STATe] <Bool>	Enables/disables channel coupling for output synchronization
:CHANnel [<NR1> {,<NR1>}]	Selects which channels are coupled
:DOFFset <NRf>	Specifies a maximum delay offset to synchronize output changes
:MAX	
:DOFFset?	Returns the maximum delay offset required for a mainframe
:DELay	
:FALL <NRf+>, (@chanlist)	Sets the output turn-off sequence delay
:RISE <NRf+>, (@chanlist)	Sets the output turn-on sequence delay
:PMODE VOLTage CURRent, (@chanlist)	Sets the mode for turn on/off transitions (N6761A, N6762A)
:TMODE HIGHZ LOWZ, (@chanlist)	Specifies the turn-on/turn-off impedance (only on N678xA SMU)
:INHibit	
:MODE LATChing LIVE OFF	Sets the remote inhibit input
:PON	
:STATe RST RCL0	Programs the power-on state
:PROTection	
:CLEar (@chanlist)	Resets latched protection
:COUPle <Bool>	Enables/disables channel coupling for protection faults
:DELay <NRf+>, (@chanlist)	Sets over-current protection programming delay
:OSCillation <Bool>, (@chanlist)	Enables/disables output oscillation protection (N678xA SMU)
:WDOG	
[:STATe] <Bool>	Enables/disables the I/O watchdog timer
:DELay <NRf+>	Sets the watchdog timer delay
:RELay	
:POLarity NORMal REVerse, (@chanlist)	Sets the output relay polarity (Option 760)
SENSe	
:CURRent	
:CCOMpensate <Bool>, (@chanlist)	Enables/disables the capacitive current compensation
[:DC]:RANGe	
[:UPPer] <NRf+>, (@chanlist)	Selects the current measurement range
:AUTO <Bool>, (@chanlist)	Enables/disables measurement autoranging (N6781A, N6782A)
:ELOG	
:CURRent	
[:DC]:RANGe	
[:UPPer] <NRf+>, (@chanlist)	Sets the external data log current range
:AUTO <Bool>, (@chanlist)	Enables/disables measurement autoranging (N6781A, N6782A)
:FUNCTion	
:CURRent <Bool>, (@chanlist)	Enables/disables external current data logging
:MINMax <Bool>, (@chanlist)	Enables/disables external min/max current data logging
:VOLTage <Bool>, (@chanlist)	Enables/disables external voltage data logging
:MINMax <Bool>, (@chanlist)	Enables/disables external min/max voltage data logging
:PERiod <NR1>, (@chanlist)	Sets the integration time of the external data logging
:VOLTage	
[:DC]:RANGe	
[:UPPer] <NRf+>, (@chanlist)	Sets the external data log voltage range
:AUTO <Bool>, (@chanlist)	Enables/disables measurement autoranging (N6781A, N6782A)
:FUNCTion "VOLTage" "CURRent" "NONE", (@chanlist)	Selects the measurement function (for backward compatibility)
:CURRent <Bool>, (@chanlist)	Enables/disables current measurements (replaces FUNCTion)
:VOLTage <Bool>, (@chanlist)	Enables/disables voltage measurements (replaces FUNCTion)
:INPut MAIN AUXiliary, (@chanlist)	Selects the voltage measurement input (only on N6781A)

SCPI Command	Description
SENSe (continued)	
:SWEep	(Sweep commands only on N676xA, N678xA SMU and Option 054)
:OFFSet	
:POINts <NRf+>, (@chanlist)	Defines the trigger offset in the measurement sweep
:POINts <NRf+>, (@chanlist)	Defines the number of data points in the measurement
:TINTerval <NRf+>, (@chanlist)	Sets the measurement sample interval
:RESolution RES20 RES40, (@chanlist)	Sets the measurement resolution
:VOLTage	
[:DC]:RANGe	
:UPPer <NRf+>, (@chanlist)	Selects the voltage measurement range
:AUTO <Bool>, (@chanlist)	Enables/disables measurement autoranging (N6781A, N6782A)
:WINDow	
[:TYPE] HANNing RECTangular, (@chanlist)	Selects measurement window (N676xA, N678xA SMU, Option 054)
[SOURce:]	
CURRent	
[:LEVel]	
[:IMMEDIATE][:AMPLitude] <NRf+>, (@chanlist)	Sets the output current
:TRIGgered [:AMPLitude] <NRf+>, (@chanlist)	Sets the triggered output current
:LIMit	
[:POSitive]	
[:IMMEDIATE][:AMPLitude] <NRf+>, (@chanlist)	Sets the positive current limit (only on N678xA SMU, N6783A)
:COUPle <Bool>, (@chanlist)	Sets the current limit tracking state (only on N678xA SMU)
:NEGative	
[:IMMEDIATE][:AMPLitude] <NRf+>, (@chanlist)	Sets the negative current limit (only on N678xA SMU, N6783A-BAT)
:MODE FIXed STEP LIST, (@chanlist)	Sets the current trigger mode
:PROTection	
:DELay	
[:TIME] <NRf+>, (@chanlist)	Sets the over-current protection programming delay
:STARt SChange CCTRans, (@chanlist)	Sets the over-current protection programming mode
:STATe <Bool>, (@chanlist)	Enables/disables over-current protection on the selected output
:RANGe <NRf+>, (@chanlist)	Sets the output current range
:SLEW	
[:IMMEDIATE] <NRf+> INFIinity, (@chanlist)	Sets the output current slew rate (only N678xA SMU)
:MAXimum <Bool>, (@chanlist)	Enables/disables the maximum slew rate override (N678xA SMU)
DIGital	
:INPut:DATA?	Reads the state of the digital port pins
:OUTPut:DATA <NRf>	Sets the digital port
:PIN<1-7>	
:FUNctIon DIO DINPut TOUTput TINPut FAULt INHibit ONCouple OFFCouple	Sets the selected pin's function
:POLarity POSitive NEGative	Sets the selected pin's polarity
:TOUTput	
:BUS[:ENABle] <Bool>	Enables/disables BUS-generated triggers on digital pins
FUNctIon CURRent VOLTage, (@chanlist)	Specifies current priority or voltage priority mode (N678xA SMU)
LIST	
:COUNt <NRf+> INFIinity, (@chanlist)	(List commands only on N676xA, N678xA SMU and Option 054) Sets the list repeat count
:CURRent	
[:LEVel] <NRf> {,<NRf>}, (@chanlist)	Sets the current list
:POINts? (@chanlist)	Returns the number of current list points

1 Quick Reference

SCPI Command	Description
[SOURce:]LIST:TOUTput (continued)	
:DWELI <NRf> {,<NRf>}, (@chanlist)	Sets the list of dwell times
:POINTs? (@chanlist)	Returns the number of dwell list points
:STEP ONCE AUTO, (@chanlist)	Specifies how the list responds to triggers
:TERMinate	
:LAST <Bool>, (@chanlist)	Sets the list termination mode
:TOUTput	
:BOSTep	
[:DATA] <Bool> {,<Bool>}, (@chanlist)	Generate triggers at the Beginning Of Step
:POINTs? (@chanlist)	Returns the number of beginning of step list points
:EOSTep	
[:DATA] <Bool> {,<Bool>}, (@chanlist)	Generate triggers at the End Of Step
:POINTs? (@chanlist)	Returns the number of end of step list points
:VOLTage	
[:LEVel] <NRf> {,<NRf>}, (@chanlist)	Sets the voltage list
:POINTs? (@chanlist)	Returns the number of voltage level points
POWer	
:LIMit <NRf+>, (@chanlist)	Sets the power limit on output channels
RESistance	
[:LEVel][:IMMEDIATE][:AMPLitude] <NRf+>, (@chanlist)	Sets the output resistance (only on N6781A)
:STATe <Bool>, (@chanlist)	Enables/disables output resistance programming (only N6781A)
STEP	
:TOUTput <Bool>, (@chanlist)	Generate a trigger output on the voltage or current step transient
VOLTage	
[:LEVel]	
[:IMMEDIATE][:AMPLitude] <NRf+>, (@chanlist)	Sets the output voltage
:TRIGgered [:AMPLitude] <NRf+>, (@chanlist)	Sets the triggered output voltage
:BWIDth LOW HIGH1 HIGH2 HIGH3, (@chanlist)	Sets the voltage bandwidth (only on N678xA SMU)
:LIMit	
[:POSitive]	
[:IMMEDIATE][:AMPLitude] <NRf+>, (@chanlist)	Sets the positive voltage limit (only on N678xA SMU)
:COUple <Bool>, (@chanlist)	Sets the voltage limit tracking state (only on N6784A)
:NEGative	
[:IMMEDIATE][:AMPLitude] <NRf+>, (@chanlist)	Sets the negative voltage limit (only on N6784A)
:MODE FIXed STEP LIST, (@chanlist)	Sets the voltage trigger mode
:PROTection	
[:LEVel] <NRf+>, (@chanlist)	Sets the over-voltage protection level
:DELay[:TIME] <NRf+>, (@chanlist)	Sets the over-voltage protection delay (only on N6783A)
:REMote	
[:POSitive][:LEVel] <NRf+>, (@chanlist)	Sets the positive remote OV protection level (only on N678xA SMU)
:NEGative[:LEVel] <NRf+>, (@chanlist)	Sets the negative remote OV protection level (only on N6784A)
:TRACking	(Tracking commands only on Option J01)
[:STATe] <Bool>, (@chanlist)	Enables/disables tracking OVP
:OFFSet <NRf+>, (@chanlist)	Sets the tracking OVP offset
:RANGe <NRf+>, (@chanlist)	Sets the output voltage range
:SLEW	
[:IMMEDIATE] <NRf+> INFIinity, (@chanlist)	Sets the output voltage slew rate
:MAXimum <Bool>, (@chanlist)	Enables/disables the maximum slew rate override

SCPI Command	Description
STATus	
:OPERation	
[:EVENT]? (@chanlist)	Returns the value of the operation event register
:CONDition? (@chanlist)	Returns the value of the operation condition register
:ENABle <NRf>, (@chanlist)	Enables specific bits in the Event register
:NTRansition <NRf>, (@chanlist)	Sets the Negative transition filter
:PTRansition <NRf>, (@chanlist)	Sets the Positive transition filter
:PRESet	Presets all enable and transition registers to power-on
:QUEStionable	
[:EVENT]? (@chanlist)	Returns the value of the questionable event register
:CONDition? (@chanlist)	Returns the value of the questionable condition register
:ENABle <NRf>, (@chanlist)	Enables specific bits in the Event register
:NTRansition <NRf>, (@chanlist)	Sets the Negative transition filter
:PTRansition <NRf>, (@chanlist)	Sets the Positive transition filter
SYSTem	
:CHANnel	
[:COUNT]?	Returns the number of output channels in a mainframe
:MODEl? (@chanlist)	Returns the model number of the selected channel
:OPTion? (@chanlist)	Returns the option installed in the selected channel
:SERial? (@chanlist)	Returns the serial number of the selected channel
:COMMunicate	
:RLState LOCAL REMote RWLock	Specifies the Remote/Local state of the instrument
:TCPip:CONTRol?	Returns the control connection port number
:ERRor?	Returns the error number and error string
:GROup	
:CATalog?	Returns the groups that have been defined
:DEFine (@chanlist)	Group multiple channels to create a single output
:DELete <channel>	Removes the specified channel from a group
:ALL	Ungroups all channels
:PASSword:FPANel:RESet	Resets the front panel lock password to zero
:REBoot	Returns the unit to its power-on state
:VERSion?	Returns the SCPI version number
TRIGger	
:ACQuire	
[:IMMEDIATE] (@chanlist)	(Acquire commands only on N676xA, N678xA SMU and Option 054) Triggers the measurement immediately
:CURRent	
[:LEVeL] <NRf>, (@chanlist)	Sets the current trigger level
:SLOPe POSitive NEGative, (@chanlist)	Sets the current trigger slope
:SOURce BUS CURRent<1-4> EXTernal PIN<1-7> TRANsient<1-4> VOLTage<1-4>, (@chanlist)	Sets the measurement trigger source
:TOUTput[:ENABle] <Bool>, (@chanlist)	Enables measurement triggers to be sent to a digital port pin
:VOLTage	
[:LEVeL] <NRf>, (@chanlist)	Sets the voltage trigger level
:SLOPe POSitive NEGative, (@chanlist)	Sets the voltage trigger slope
:ELOG	
[:IMMEDIATE] (@chanlist)	Triggers the external data log immediately
:SOURce BUS EXTernal IMMEDIATE PIN<1-7>, (@chanlist)	Sets the external data log trigger source
:TRANsient	
[:IMMEDIATE] (@chanlist)	Triggers the output immediately
:SOURce BUS EXTernal IMMEDIATE PIN<1-7> TRANsient<1-4>, (@chanlist)	Sets the output trigger source

Common Commands

Command	Description	Command	Description
*CLS	Clear status	*RDT?	Return output channel descriptions
*ESE <NRf>	Standard event status enable	*RST	Reset
*ESR?	Return event status register	*SAV <NRf>	Saves an instrument state
*IDN?	Return instrument identification	*SRE <NRf>	Set service request enable register
*LRN	Returns a sequence of SCPI commands	*STB?	Return status byte
*OPC	Enable "operation complete" bit in ESR	*TRG	Trigger
*OPT?	Return option number	*TST?	Performs self-test, then returns result
*RCL <NRf>	Recalls a saved instrument state	*WAI	Waits until all device commands are done

*RST Settings

CAL:STAT	OFF	SENS:ELOG:CURR:RANG:AUTO	OFF
CURR	0.08 or MIN	SENS:ELOG:FUNC:CURR	ON
CURR:LIM	MAX	SENS:ELOG:FUNC:CURR:MINM	OFF
CURR:LIM:COUP	ON	SENS:ELOG:FUNC:VOLT	OFF
CURR:LIM:NEG	MIN	SENS:ELOG:FUNC:VOLT:MINM	OFF
CURR:MODE	FIX	SENS:ELOG:PER	0.1
CURR:PROT:DEL	0.02	SENS:ELOG:VOLT:RANG:AUTO	OFF
CURR:PROT:DEL:STAR	SCH	SENS:FUNC	"VOLT"
CURR:PROT:STAT	OFF	SENS:FUNC:CURR	OFF
CURR:RANG	MAX	SENS:FUNC:VOLT	ON
CURR:SLEW	9.9E+37	SENS:FUNC:VOLT:INP	MAIN
CURR:SLEW:MAX	ON	SENS:SWE:POIN	1024 or 4883
CURR:TRIG	MIN	SENS:SWE:OFFS:POIN	0
DIG:OUTP:DATA	0	SENS:SWE:TINT	20.48E-6
DISP:VIEW	METER1	SENS:SWE:TINT:RES	RES20
INIT:CONT:TRAN	OFF	SENS:VOLT:RANG	MAX
LIST:COUN	1	SENS:VOLT:RANG:AUTO	OFF
LIST:CURR	MIN	SENS:WIND	RECT
LIST:DWEL	0.001	STEP:TOUT	FALSE
LIST:STEP	AUTO	TRIG:ACQ:CURR	MIN
LIST:TERM:LAST	OFF	TRIG:ACQ:CURR:SLOP	POS
LIST:TOUT:BOST	OFF	TRIG:ACQ:SOUR	BUS
LIST:TOUT:EOST	OFF	TRIG:ACQ:TOUT	OFF
LIST:VOLT	MIN	TRIG:ACQ:VOLT	MIN
OUTP	OFF	TRIG:ACQ:VOLT:SLOP	POS
OUTP:COUP	OFF	TRIG:ELOG:SOUR	BUS
OUTP:DEL:FALL	0	TRIG:TRAN:SOUR	BUS
OUTP:DEL:RISE	0	VOLT	MIN
OUTP:PMOD	VOLT	VOLT:BWID	LOW
OUTP:TMOD	LOWZ	VOLT:LIM	MAX
OUTP:PROT:COUP	OFF	VOLT:LIM:COUP	ON
OUTP:PROT:DEL	0.02	VOLT:LIM:NEG	MIN
OUTP:PROT:OSC	ON	VOLT:MODE	FIX
OUTP:PROT:WDOG	OFF	VOLT:PROT:DEL	0
OUTP:REL:POL	NORM	VOLT:PROT:REM	MAX
POW:LIM	MAX	VOLT:PROT:REM:NEG	MIN
RES	0	VOLT:RANG	MAX
RES:STAT	OFF	VOLT:SLEW	9.9E+37
SENS:CURR:CCOM	ON	VOLT:SLEW:MAX	ON
SENS:CURR:RANG	MAX	[SOUR:]VOLT:TRIG	MIN
SENS:CURR:RANG:AUTO	OFF		

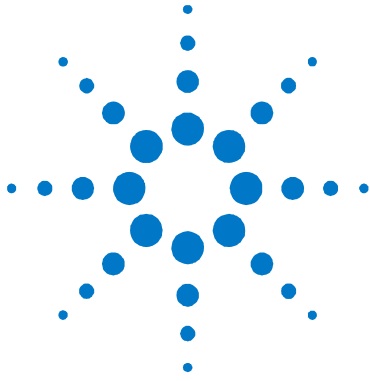

2 Installation



General Information	24
Inspecting the Unit	25
Installing the Unit	26
Connecting the Line Cord	30
Connecting the Outputs	31
Remote Sense Connections	36
Parallel Connections	38
Series Connections	40
Additional Load Considerations	42
Connecting the Auxiliary Voltage Measurement Input	44

This chapter describes how to install your power system. It discusses rack mounting and line cord connections.

This chapter also discusses how to connect your load to the output terminals. It discusses what you need to know about wire sizes and how to compensate for voltage drops in the load leads. It describes various loads configurations and how to connect the output terminals in series and parallel.

Before installing the instrument, check the list under “Items Supplied” and verify that you have received these items with your instrument. If anything is missing, please contact your nearest Agilent Sales and Support Office.

General Information

Models

Agilent Model	Description
N6700B / N6701A / N6702A	400 W / 600 W / 1200W MPS Mainframe - without power modules
N6710B / N6711A / N6712A	Build-to-order Modular Power System – mainframe with installed power modules
N6731B / N6741B	50 W / 100 W 5 V DC Power Module
N6732B / N6742B	50 W / 100 W 8 V DC Power Module
N6733B / N6743B / N6773A	50 W / 100 W / 300 W 20 V DC Power Module
N6734B / N6744B / N6774A	50 W / 100 W / 300 W 35 V DC Power Module
N6735B / N6745B / N6775A	50 W / 100 W / 300 W 60 V DC Power Module
N6736B / N6746B / N6776A, N6777A	50 W / 100 W / 300 W 100 V DC Power Module
N6751A / N6752A	50 W / 100 W High-Performance Autoranging DC Power Module
N6753A, N6754A / N6755A , N6756A	300 W / 500 W High-Performance Autoranging DC Power Module
N6761A / N6762A	50 W / 100 W Precision DC Power Module
N6763A, N6764A / N6765A, N6766A	300 W / 500 W Precision DC Power Module
N6781A, N6782A, N6784A	20 W Source/Measure Unit (SMU)
N6783A-MFG / N6783A-BAT	18 W / 24 W Application-Specific DC Power Module

Options

Mainframe Options	Description
0L1	English Manual Set. Contains User's Guide and Service Guide. Also available as part number 5969-2939.
908	Rack Mount Kit. For mounting in a 19-inch EIA rack cabinet. Also available as Model N6709A.
FLR	Filler module. For mainframes with less than four power modules. Also available as Model N6708A.
Power Module Options	
054	High-Speed Test Extensions. Includes digitized output measurements and output list capability. Available for Models N673xB,- 4xB,-5xA, -7xA. Included with Models N676xA, N678xA SMU, and N6783A.
760 ^{NOTE 1}	Output disconnect/polarity reversal. Disconnects the + and – output and sense terminals. Switches the + and – output and sense polarities. Not available on N6741B, N6751A, N6752A, N676xA, or N678xA.SMU.
761 ^{NOTE 1}	Output disconnect. Disconnects + and – output and sense terminals. Available for all power modules.
UK6	Commercial calibration with test results data
1A7	ISO 17025 calibration certificate
2UA	200 microampere measurement range with output disconnect relays. Only on Models N6761A, N6762A.
J01	Tracking overvoltage protection function. Only available on Models N6752A, N6754A, and N6762A when installed in an N6700B, N6701A, or N6702A mainframe.

¹ A small AC network is always present across the output terminals.

Items Supplied

Mainframe Items	Description	Part Number
Power Cord	A power cord suitable for your location.	Call Agilent Sales & Support Office
Ferrite Core	Installs on power cord to reduce common mode currents.	Agilent 9170-2131
Digital Connector plug	8-pin connector for connecting signal lines to the digital port.	Agilent 1253-6408 Phoenix Contact MC 1,5/8-ST-3,5
Product Reference CD-ROM	Includes drivers and documentation.	Agilent 5969-2914
Automation-Ready CD-ROM	Contains Agilent IO Libraries Suite.	Agilent E2094N
Quick Reference Guide	Contains quick reference information.	Agilent 5969-2950
T-10 Torx tool	Torx tool for installing or removing power modules.	Agilent 8710-2416
Power Module Items		
8 A Output Connector plug	One 8 A, 8-pin connector plug for connecting power and sense leads. Only used in N678xA SMU.	Agilent 1253-6408 Phoenix Contact MC 1,5/8-ST-3,5
12 A Output Connector plug	One 12 A, 4-pin connector plug for connecting power and sense leads. Used in all except N6731B, N6741B, N6753A-N6756A, N6763A-N6766A, N6773A, N678xA SMU.	Agilent 1253-5826 Phoenix Contact MSTB 2,5/4-STF
20 A Output Connector plug	One 20 A, 4-pin connector plug for connecting power and sense leads. Only used in N6731B, N6741B, N6754A, N6756A, N6764A, N6766A, N6773A.	Agilent 1253-6211 Phoenix Contact PC 4/4-ST-7,62
50 A Output Connector plug	One 50 A, 2-pin connector plug for connecting power leads. Only used in N6753A, N6755A, N6763A, N6765A.	Agilent 1253-7187 Molex 39422-0002
AUX Measurement connector plug	A 2-pin connector plug for connecting the auxiliary measurement inputs. Only used in N6781A.	Agilent 1253-8485 Phoenix Contact FMC 1,5/2-ST-3,5
Small Sense Jumpers	Two small jumpers for local sensing at the output connector. Used in all except N6731B, N6741B, N6753A-N6756A, N6763A-N6766A, N6773A, N678xA SMU.	Agilent 8120-8821 Phoenix Contact EPB 2-5(1733169)
Large Sense Jumpers	Two large jumpers for local sensing at the output connector. Only used in N6731B, N6741B, N6754A, N6756A, N6764A, N6766A, N6773A.	Agilent 0360-2935 Phoenix Contact 3118151
Sense Connector	A 4-pin connector for connecting sense leads. Wires (p/n 5185-8847) are used for local sensing. Only used in N6753A, N6755A, N6763A, N6765A.	Agilent 1253-5830 Phoenix Contact MC 1,5/4-ST-3,5
Module Cal. Certificate	A certificate of calibration referenced to the serial number.	N/A

Inspecting the Unit

When you receive your power system, inspect it for any obvious damage that may have occurred during shipment. If there is damage, notify the shipping carrier and nearest Agilent Sales and Support Office immediately. Refer to www.agilent.com/find/assist.

Until you have checked out the power system, save the shipping carton and packing materials in case the unit has to be returned. Check the list under “Items Supplied” and verify that you have received these items with your instrument. If anything is missing, please contact your nearest Agilent Sales and Support Office.



Installing the Unit

Safety Considerations

This power system is a Safety Class 1 instrument, which means it has a protective earth terminal. That terminal must be connected to earth ground through a power source equipped with a ground receptacle.

Refer to the Safety Summary page at the beginning of this guide for general safety information. Before installation or operation, check the power system and review this guide for safety warnings and instructions. Safety warnings for specific procedures are located at appropriate places throughout this Guide.

Environment

WARNING Do not operate the instrument in the presence of flammable gasses or fumes

The environmental conditions of the instrument are documented in Appendix A. Basically, the instrument should only be operated indoors in a controlled environment.

The dimensions of your instrument as well as an outline diagram are given in Appendix A. A fan cools the power system by drawing air through the sides and exhausting it out the side and back. The instrument must be installed in a location that allows sufficient space at the sides and back of the unit for adequate air circulation.

Cleaning

WARNING **SHOCK HAZARD** To prevent electric shock, unplug the unit before cleaning.

Use a dry cloth or one slightly dampened with water to clean the external case parts. Do not use detergent or chemical solvents. Do not attempt to clean internally.

Power Module Channel Assignment

The slot location of a power module in the mainframe determines the channel assignment of the module. When viewed from the rear, the module next to the GPIB connector is always output channel one. Numbering continues sequentially to the left, from one up to four.

Double-wide power modules are assigned the number of the **lowest** numbered slot in which is installed. For example, if a double-wide module is installed in slots 3 and 4, it is assigned channel number 3.

Grouped power modules, those that are connected in parallel and have been configured or grouped to act as a single higher-power channel, are assigned the channel number of the **lowest** numbered slot of the group.

Power Module Installation

NOTE

The information in this section applies if you have purchased an N6700 mainframe without the power modules installed, or if you are adding a power module to the mainframe.

CAUTION

Turn the mainframe off and disconnect the power cord before installing or removing power modules. Observe all standard electrostatic discharge precautions before handling electronic components.

Modules must be installed next to one another, starting with slot 1. Do not leave any empty slots *between* modules, otherwise the power system will not operate. Any remaining unused slots must have a filler module installed to ensure proper cooling. Do not install filler modules *between* power modules.

Tools required: T10 Torx driver;
Small flat-blade screwdriver

Firmware Note: Newer power modules can only be installed in N6700 mainframes with the latest firmware. Refer to the “Updates” section in the front of this manual for more information. If your mainframe has the latest firmware version, install the power module. If not, download and install the latest version firmware from the web.

Step 1. Remove the blower cover. Remove the screws from the top and sides of the blower cover. Tilt the cover up and slide it out.

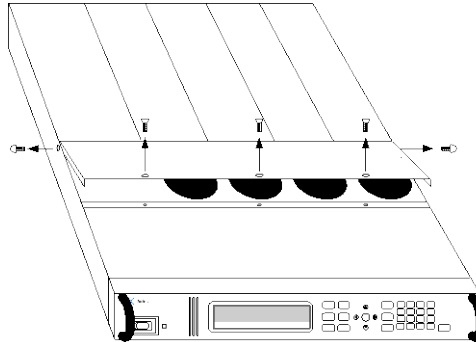

Step 2. To install a power module, align the module over the pins and push it down onto the mainframe connector.

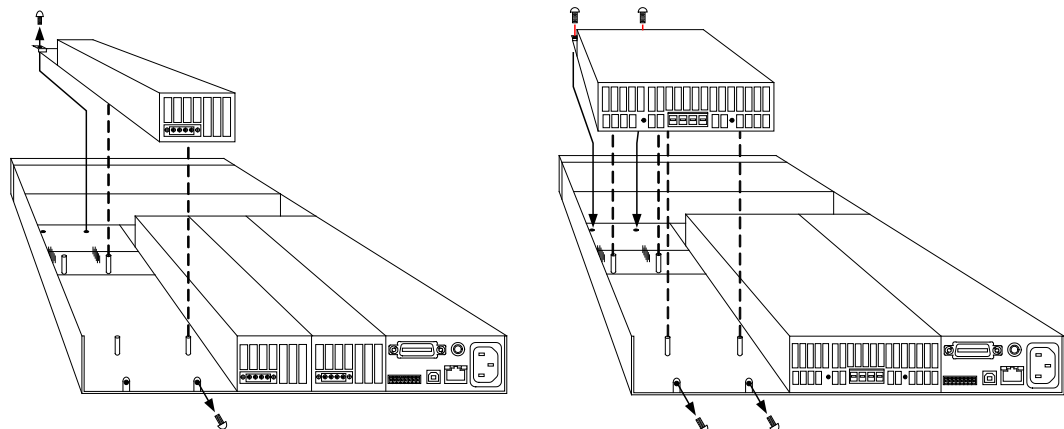

- Step 3.** Use a T10 Torx driver and install the screws at each end of the power module. Because the RFI strips apply upward pressure, continue pushing down on the module until the screws are tight.
- Step 4.** Replace the blower cover when finished. Carefully fit the spring clips under the lip of the power modules.

Rack Installation

CAUTION

You cannot use support rails for rack mounting your instrument.

Support rails would block the airflow needed for cooling.

Use Rack Mount kit (Option 908) to rack mount your instrument.

The Rack Mount Kit is also available by ordering part number N6709A.

Agilent N6700 MPS mainframes can be mounted in a 19-inch EIA rack cabinet. They are designed to fit in one rack-unit (1U) of space. Do not block the air intake and exhaust at the sides of the unit, or the exhaust at the rear of the unit.

Tools required: Phillips driver, T22 Torx driver, T10 Torx driver

- Step 1.** Install eight clip-nuts on the rack frame (2 in each corner) where your instrument will be located.

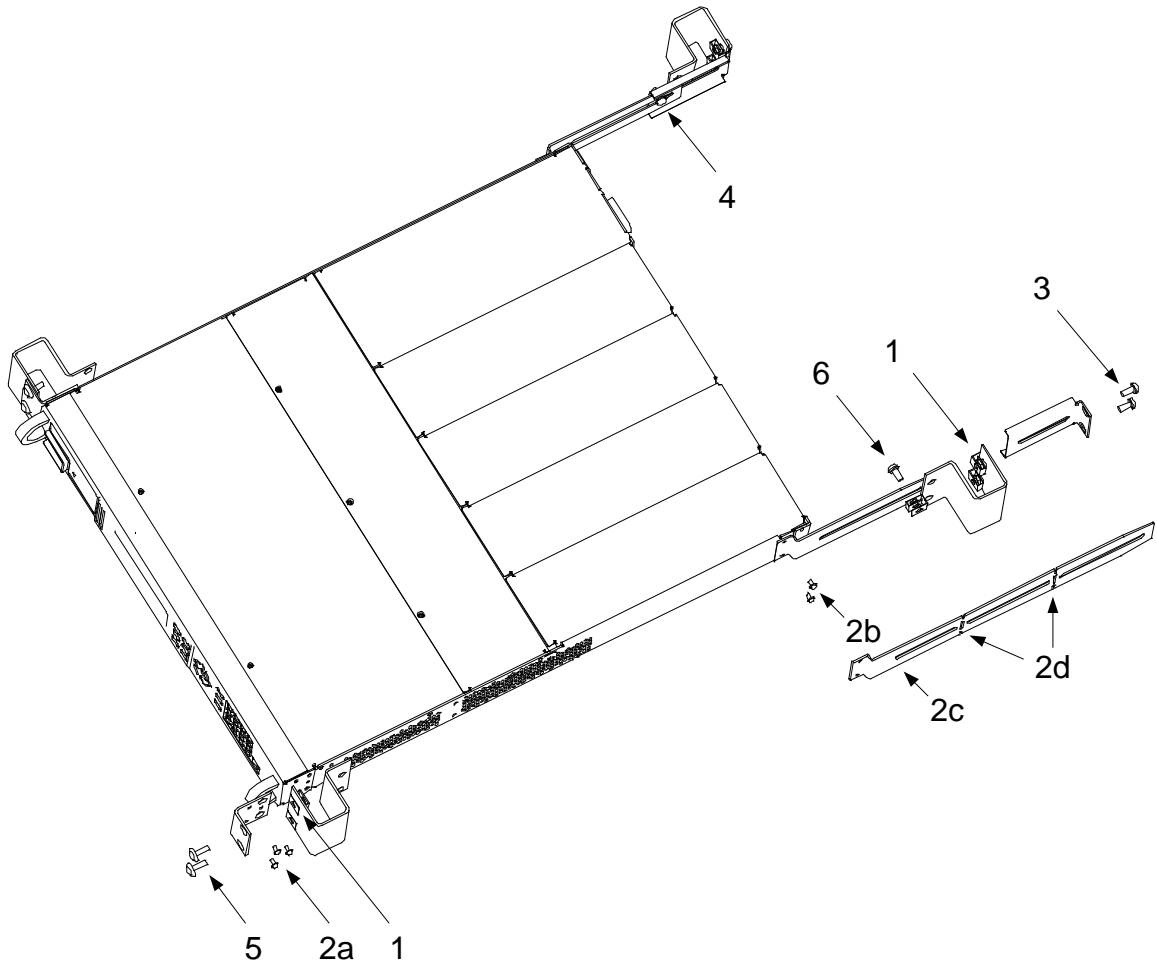

- Step 2.** Install the two front ears and the two rear extender supports on the instrument as shown in the figure. Use six M3 x 8mm screws (a) for the front ears and four M3 x 6mm screws (b) for the extender supports. If the standard extender supports are either too short or too long, use the longer supports (c). Cut the supports if required (d).
- Step 3.** Install the two rear ears on the back of the instrument rack as shown in the figure. Use four plain 10-32 screws to install the rear ears.
- Step 4.** Slide the instrument into the rack, making sure that the rear extender supports are aligned inside the rear ears.
- Step 5.** Attach the front ears to the front of the instrument rack using the four dress 10-32 screws provided.
- Step 6.** This is optional. Insert a plain 10-32 screw through the slot of the rear ear and extender support. Attach it with a clip-nut. Note that this will prevent the unit from being slid out of the front of the rack.

Bench Installation

CAUTION

Do not block the air intake and exhaust at the sides, or the exhaust at the rear of the unit. Refer to the outline diagram in Appendix A.

Minimum clearances for bench operation are 2 inches (51 mm) along the sides and back.

400 Hz Operation

Redundant Ground Requirement

At 400 Hz AC input operation, the leakage current of the unit exceeds 3.5 mA. This requires the installation of a permanent, redundant ground from the instrument chassis to earth ground. This ensures that ground will always be connected and that any leakage current will be diverted to ground. Refer to the Service Guide for installation instructions.

Power Factor

Refer to Appendix A for power factor statistics at 400 Hz operation.

Connecting the Line Cord

WARNING

FIRE HAZARD Use only the power cord that was supplied with your instrument. Using other types of power cords may cause overheating of the power cord, resulting in fire.

SHOCK HAZARD The power cord provides a chassis ground through a third conductor. Be certain that your power outlet is of the three-conductor type with the correct pin connected to earth ground.

Connect the power cord to the IEC 320 connector on the rear of the unit. If the wrong power cord was shipped with your unit, contact your nearest Agilent Sales and Support Office.

The AC input on the back of your unit is a universal AC input. It accepts nominal line voltages in the range of 100 VAC to 240 VAC. The frequency can be 50 Hz, 60 Hz, or 400 Hz.

Agilent N6702A Mainframe Note: Standard AC mains circuits rated at nominal 100-120 VAC cannot supply enough current to power the N6702A mainframe when it is operated at its full rated power. Nevertheless, the N6702A can be connected to an AC mains circuit rated at nominal 100-120 VAC. In this case, internal circuits will limit the power available to modules to 600 W. As a result of this power limiting, the current drawn from the AC mains will be < 15 A, so that standard 100-120 VAC mains circuits will not be overloaded.

NOTE

The detachable power cord may be used as an emergency disconnecting device. Removing the power cord will disconnect AC input power to the unit.

Snap-On Ferrite Core

Installing the ferrite core is only necessary if you are connecting highly sensitive loads to the output of the power system. The purpose of the ferrite core is to reduce the possibility of common mode current spikes appearing at the output of the power system when AC power is switched on or off.

Additional measures to protect sensitive loads from common mode currents are discussed under “Protecting Sensitive Loads from AC Power Switching Transients” later in this chapter.

Installation

- Locate the core anywhere along the length of the cord.
- Pass the power cord through the core twice.
- Close the core.

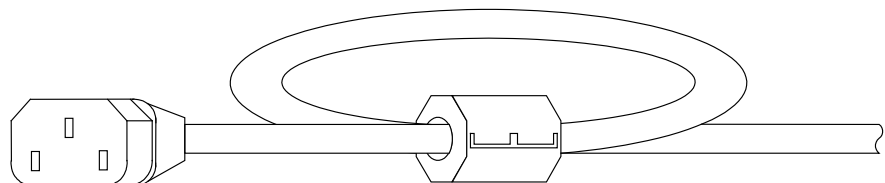

Connecting the Outputs

WARNING

SHOCK HAZARD Turn off AC power before making rear panel connections. All wires and straps must be properly connected with the terminal block screws securely tightened.

Disconnect the connector plug to make your wire connections. The 8A connector plug accepts wires sizes from AWG 14 to AWG 30. The 12A connector plug accepts wires sizes from AWG 12 to AWG 30. The 20A connector plug accepts wires sizes from AWG 10 to AWG 24. The 50A connector plug accepts wires sizes from AWG 6 to AWG 20. Wire sizes smaller than AWG 20 are not recommended. Connect the load wires to the + and - terminals. Connect the sense wires to the +s and -s terminals. Sense jumpers are provided for local sensing.

Securely fasten all wires by tightening the screw terminals. Insert the connector plug into the back of the unit. Secure the 12 A and 50 A connector by tightening the locking screws. A chassis ground binding post is located next to the AC input connector for ground connections.

Part number information for all connector plugs is provided under “Items Supplied” at the beginning of this chapter.

CAUTION

On power modules with the 50A sense connector, the +LS and –LS terminals are ONLY used for local sense connections as illustrated. Do not connect these terminals in any other way.

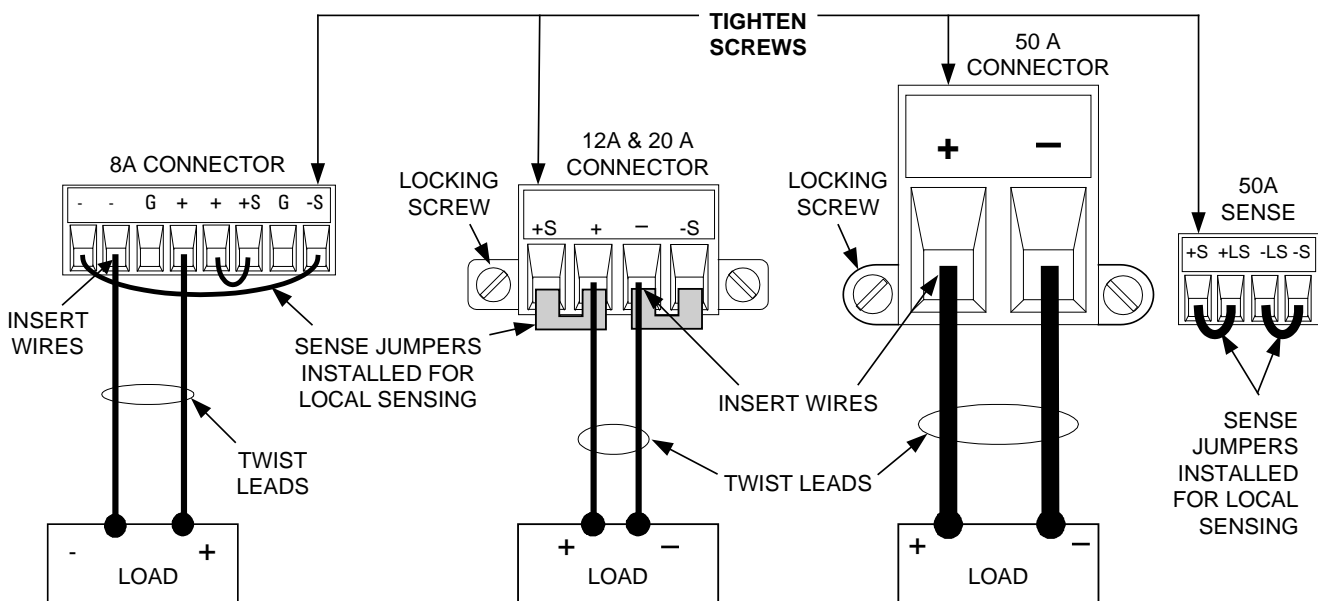

Wire Size

WARNING

FIRE HAZARD Select a wire size large enough to carry short-circuit current without overheating (refer to the table below). To satisfy safety requirements, load wires must be heavy enough not to overheat while carrying the short-circuit output current of the unit. Agilent Model N678xA SMU wiring requirements are described on the following page.

Along with conductor temperature, you must also consider voltage drop when selecting wire sizes. The following table lists the resistance for various wire sizes and the maximum lengths to limit the voltage drop to 1.0 V per lead for various currents.

Note that the minimum wire size required to prevent overheating may not be large enough to prevent over-voltage tripping or maintain good regulation. Under most conditions, the load wires should also be heavy enough to limit the voltage drop to no more than 1.0 V per lead.

To help prevent nuisance tripping of the over-voltage circuit, select a wire size sufficient to handle the FULL output current of the unit no matter what the intended load current or current limit setting

Load lead resistance is also an important factor relating to the CV stability of the instrument when remote sensing capacitive loads. If high capacitance loads are expected, you should not use wire gauges heavier than 12 to 14 AWG for long runs of load lead.

Wire size	Current-carrying capacity in Amps for stranded copper wire		Resistance	Max. Length to Limit Voltage to 1 V/Lead			
	2 wires bundled	4 wires bundled		for 5 A	for 10 A	for 20A	for 50 A
AWG	2 wires bundled	4 wires bundled	Ω/foot	Wire length in feet			
20	7.8	6.9	0.0102	20	x	x	x
18	14.5	12.8	0.0064	30	15	x	x
16	18.2	16.1	0.0040	50	25	x	x
14	29.3	25.9	0.0025	80	40	20	x
12	37.6	33.2	0.0016	125	63	30	x
10	51.7	45.7	0.0010	200	100	50	20
8	70.5	62.3	0.0006	320	160	80	32
6	94	83	0.0004	504	252	126	50
Area in mm²	2 wires bundled	4 wires bundled	Ω/meter	Wire length in meters			
0.5	7.8	6.9	0.0401	5	x	x	x
0.75	9.4	8.3	0.0267	7.4	x	x	x
1	12.7	11.2	0.0200	10	5	x	x
1.5	15.0	13.3	0.0137	14.6	7.2	x	x
2.5	23.5	20.8	0.0082	24.4	12.2	6.1	x
4	30.1	26.6	0.0051	39.2	19.6	9.8	3.9
6	37.6	33.2	0.0034	58	29	14.7	5.9
10	59.2	52.3	0.0020	102	51	25	10.3

Notes: 1. Capacity for AWG wires derived from MIL-W-5088B. Max. ambient temp: 55°C. Max. wire temp: 105°C.

2. Capacity for metric wires are derived from IE Publication 335-1.

3. Capacity of aluminum wire is approximately 84% of that listed for copper wire.

4. "x" indicates wire is not rated for the maximum output current of the power module.

5. Because of wire inductance considerations, it is also recommended that you keep your load leads twisted, tie wrapped, or bundled together and less than 50 feet (14.7 meters) in length per lead.

Agilent N678xA SMU Wiring Requirements

NOTE

Because of the effect of wire inductance, the wire length information given in the previous table does not apply to Agilent Models N678xA SMU.

To minimize the effect of wire inductance, the following table describes the allowable load lead and wire length for several common output wire types. Using longer (or shorter) wire lengths than those indicated in the table may cause output oscillation.

Cable Type	To module connector	
	Length in feet	Length in meters
Twisted pair (AWG 14 or smaller)	1 to 4.25 ft	0.3 to 1.3 m
50 ohm coaxial (RG-58)	2 to 10 ft	0.6 to 3 m
10 ohm coaxial (inductance per cable foot ≤ 32 nH)	8.5 to 33 ft	2 to 10 m

High Bandwidth Modes with Remote Sensing

The following wiring requirements apply when using Agilent Models N678xA SMU in the High bandwidth modes with remote sensing.

Refer to chapter 4 under “Output Bandwidth” for more information about the bandwidth settings.

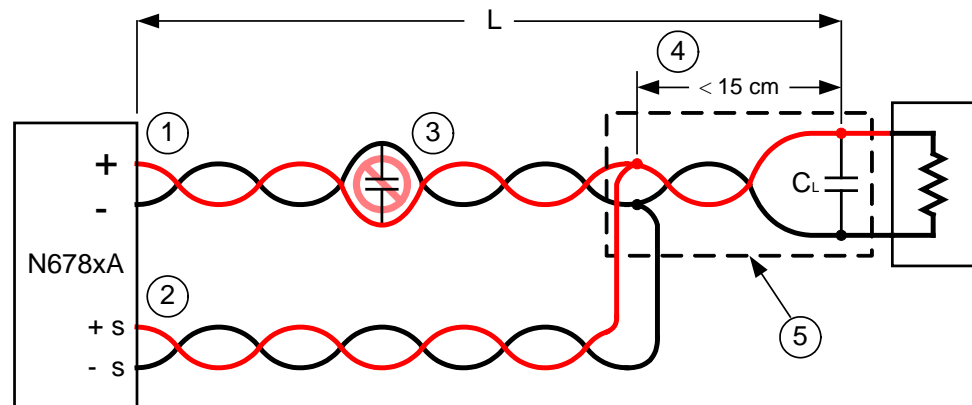

- 1) Load wires must be twisted-pair or coax and must *not* be twisted with the sense wires. Refer to the above table for length (L).
- 2) Sense wires must be twisted-pair or coax and must *not* be twisted with the load wires.
- 3) No capacitors are allowed within the sense-compensated load path.
- 4) If the load capacitor (C_L) is not located at the sense point, the distance from the sense point to the load capacitor cannot exceed 15 cm and must be twisted-pair, coax, or pc traces.
- 5) If the test fixture consists of pc traces, the positive and negative traces should be directly facing on adjacent layers.

To minimize inductance, the width (w) of the traces should be *at least* as great as the thickness of the dielectric (h). It is better to make the traces much wider than this minimum requirement in order to minimize the DC resistance.

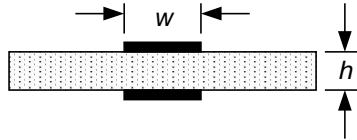

Low Bandwidth Mode with Remote or Local Sensing

All previously stated wiring requirements still apply in Low bandwidth mode except for the following.

The 15 cm maximum limit between the sense point and the load capacitor (see #4) does not apply when using Low bandwidth mode.

Guard Connection

The purpose of a cable guard is to eliminate the effects of leakage current that can exist in the current path of the external test circuit. The cable guard can be used when the test fixture requires guarding and the power system is sourcing or measuring DC currents under 1 μ A. Without a guard, leakage currents in the test circuit could affect the accuracy of the micro-amp measurements. Guarding is generally not required when measuring currents 1 μ A and greater.

As shown below, cable guards are available at the output connector of Agilent Models N678xA SMU. The guard is typically used to drive the shields of cables and test fixtures. It provides a buffered voltage that is at the same potential as the + output terminals of the module connector. The guard current is limited to about 300 μ A.

- 1. N678xA SMU connector
- 2. Guard shield (can be the shield of a coaxial cable)

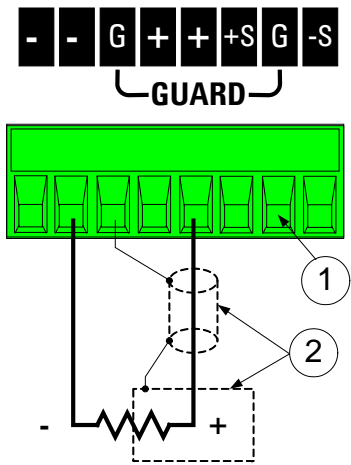

Multiple Loads

If you are using local sensing and are connecting multiple loads to one output, connect each load to the output terminals using separate connecting wires as shown in the following figure.

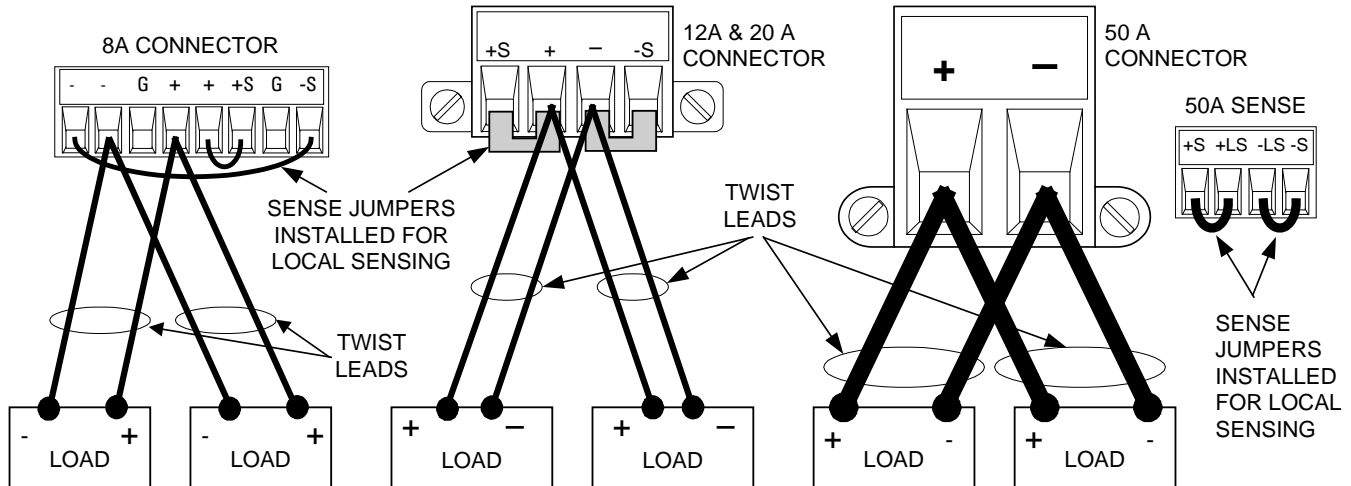

This minimizes mutual coupling effects and takes full advantage of the power system's low output impedance. Keep each pair of wires as short as possible and twist or bundle them to reduce lead inductance and noise pickup.

Note that Agilent Models N678xA SMU have additional wiring restrictions as discussed under “Agilent N678xA SMU Wiring Requirements”.

If load considerations require the use of distribution terminals that are located away from the instrument, connect the output terminals to the remote distribution terminals by a pair of twisted or bundled wires. Connect each load to the distribution terminals separately. Remote voltage sensing is recommended under these circumstances. Sense either at the remote distribution terminals or, if one load is more sensitive than the others, directly at the critical load.

Remote Sense Connections

WARNING

SHOCK HAZARD Turn off AC power before making or changing rear panel connections.

Remote sensing improves the voltage regulation at the load by monitoring the voltage there instead of at the output terminals. This allows the power system to automatically compensate for the voltage drop in the load leads. Remote sensing is especially useful for CV operation with load impedances that vary or have significant lead resistance. It has no effect during CC operation. Because sensing is independent of other power system functions, remote sensing can be used regardless of how the power system is programmed.

Connect the unit for remote sensing by first disconnecting the straps between sense and load terminals. Make your connections as shown in the following figure. Connect the load to the output terminals using separate connecting wires. Keep the wire-pair as short as possible and twist or bundle it to reduce lead inductance and noise pickup. Keep load leads under 14.7 meters (50 feet) per lead because of inductance effects.

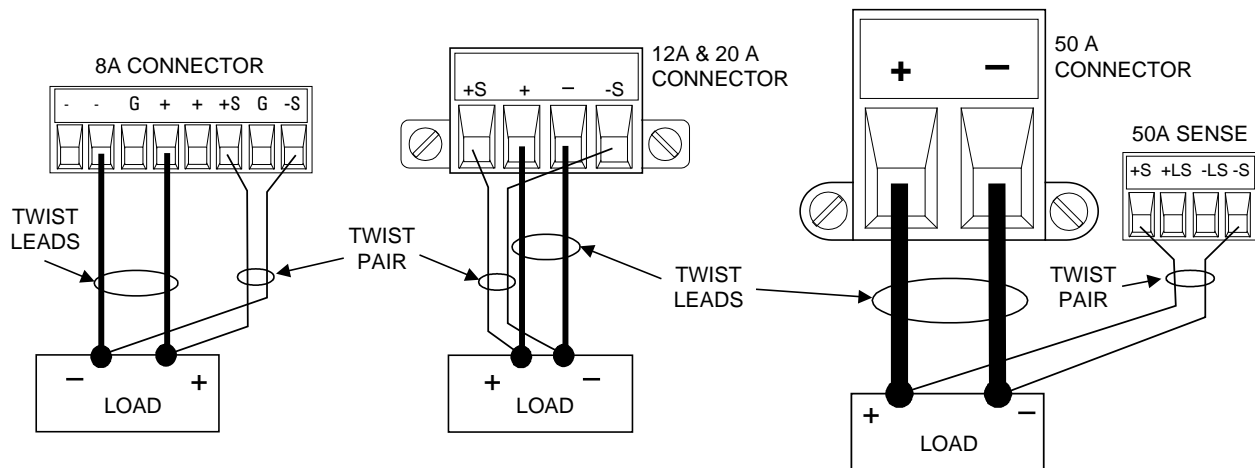

Connect the sense leads as close to the load as possible. Do NOT bundle the sense wire-pair together with the load leads; keep the load wires and sense wires separate. Note that the sense leads carry only a few milliamperes of current and can be a lighter gauge than the load leads. However, note that any voltage drop in the sense leads can degrade the voltage regulation of the instrument. Try to keep the sense lead resistance less than about 0.5Ω per lead (this requires 20 AWG or heavier for a 50 foot length).

Note that Agilent Models N678xA SMU require remote sensing when using any of the High output bandwidth modes discussed in Chapter 4. Also, these models have additional wiring restrictions as discussed under “Agilent N678xA SMU Wiring Requirements”.

CAUTION

When remote sensing on power modules with the 50A sense connector, do not connect the +LS and -LS terminals. These are dedicated for local sensing only.

Open Sense Leads

The sense leads are part of the output's feedback path. Connect them in such a way so that they do not inadvertently become open circuited. The power system includes protection resistors that reduce the effect of open sense leads during remote-sensing operation. If the sense leads open during operation, the power system returns to the local sensing mode, with the voltage at the output terminals approximately 1% higher than the programmed value.

Over-voltage Protection Considerations

You must take into account any voltage drop in the load leads when setting the over-voltage trip point. This is because the OVP circuit senses at the output terminals and not at the sense terminals. Due to the voltage drop in the load leads, the voltage sensed by the OVP circuit could be higher than the voltage being regulated at the load.

Note that for Agilent Models N678xA SMU only, the OVP circuit senses at the 4-wire sense terminals rather than at the output terminals. This allows for more precise overvoltage monitoring directly at the load. Since incorrect sense terminal wiring could defeat this feature, there is also a backup local OVP function.

The local OVP function tracks the programmed OVP setting and trips if the voltage at the + and - output terminals rises more than 1.5 V above the programmed OVP setting. The local OVP also trips if the voltage at the + and - output terminals exceeds 7.5 V on the 6 V range and 21.5 V on the 20 V range.

Output Noise Considerations

Any noise picked up on the sense leads will appear at the output terminals and may adversely affect CV load regulation. Twist the sense leads or use a ribbon cable to minimize the pickup of external noise. In extremely noisy environments it may be necessary to shield the sense leads. Ground the shield at the power system end only; do not use the shield as one of the sensing conductors.

The noise specifications documented in the Agilent N6700 Modular Power System Family Specifications Guide apply at the output terminals when using local sensing. However, voltage transients may be produced at the load by noise induced in the leads or by load current transients acting on the inductance and resistance of the load lead. If it is desirable to keep voltage transient levels to a minimum, place an aluminum or tantalum capacitor, with an approximate value of 10 μF per foot (30.5 cm) of load lead, right across the load.

Parallel Connections

CAUTION

Only connect outputs that have identical voltage and current ratings in parallel. Agilent Models N678xA SMU cannot be connected in parallel.

Connecting outputs in parallel provides a greater current capability than can be obtained from a single output.

The following figures show how to connect two outputs in parallel. The figure on the left illustrates local sensing. If voltage drop in the load leads is a concern, the figure on the right shows how to connect the sense leads directly at the load. Note that in both cases, the remote sense terminals must be connected together.

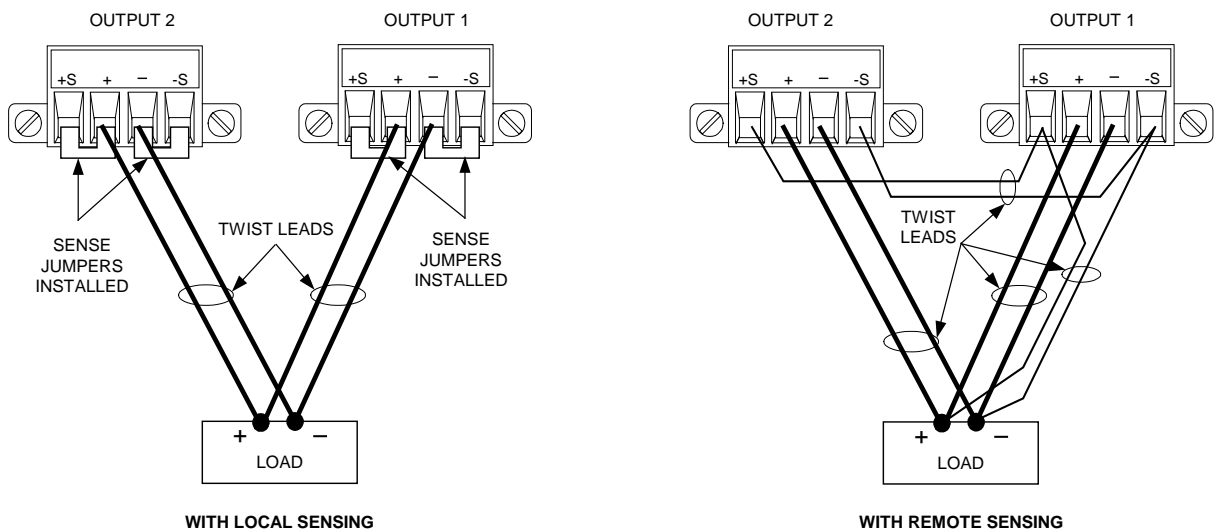

The following figure shows the connections for 50A power modules.

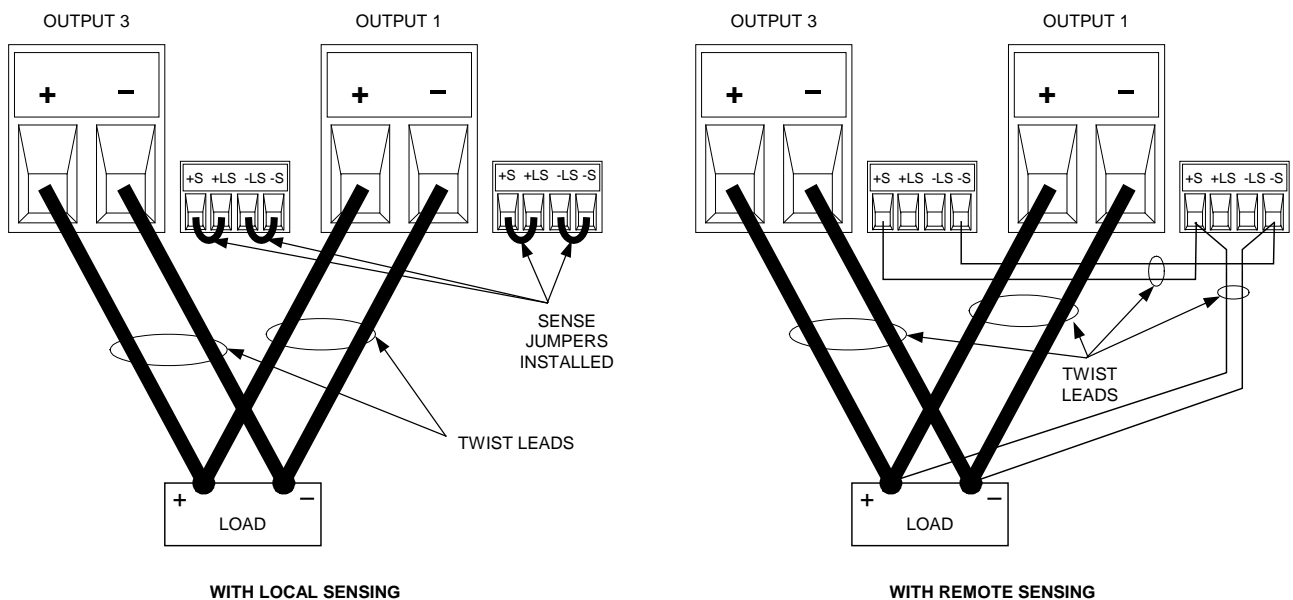

Grouping the Outputs

Once outputs have been connected in parallel, they can be configured or “grouped” to act as a single, higher-power channel. This applies when programming via the front panel or using SCPI commands. How to group output channels that have been connected in parallel is discussed in Chapter 4 under “System-Related Operations”.

If you are not grouping output channels, first program both outputs to the desired output voltage. Then program the current limit point of each output. The current limit of the paralleled outputs will be the sum of both individual current limit points.

Effect on Specifications

Specifications for outputs operating in parallel can be obtained from the specifications for single outputs. Most specifications are expressed as a constant or as a percentage (or ppm) plus a constant. For parallel operation, the percentage portion remains unchanged while constant portions or any constants are changed as indicated below. For current readback accuracy and temperature coefficient of current readback, use the minus current specifications:

Current All parallel specifications referring to current are twice the single output specification except for programming resolution, which is the same for both single output and parallel output operation.

Voltage All parallel specifications referring to voltage are the same as for a single output except for CV load effect, CV load cross regulation, CV source effect, and CV short term drift. These are all twice the voltage programming accuracy (including the percentage portion) at all operating points.

Load Transient Recovery Time Load transient specifications are typically twice the single output.

Series Connections

WARNING

SHOCK HAZARD Floating voltages must not exceed 240 VDC. No output terminal may be more than 240 VDC from chassis ground.

CAUTION

Only connect outputs that have identical voltage and current ratings in series. Agilent Models N678xA SMU and N6783A-x cannot be connected in series.

To prevent currents from damaging the power system when the load is connected, always turn series-connected outputs on and off together. Do not leave one output on while the other is off.

Connecting outputs in series provides a greater voltage capability than can be obtained from a single output. Because the current is the same through each element in a series circuit, outputs connected in series must have equivalent current ratings.

The following figures show how to connect two outputs in series to a single load. If voltage drop in the load leads is a concern, connect the sense leads of output 1 and output 2 for remote sensing as shown in the figure on the right. Note that the +sense lead of output 1 must remain connected to the -sense terminal of output 2.

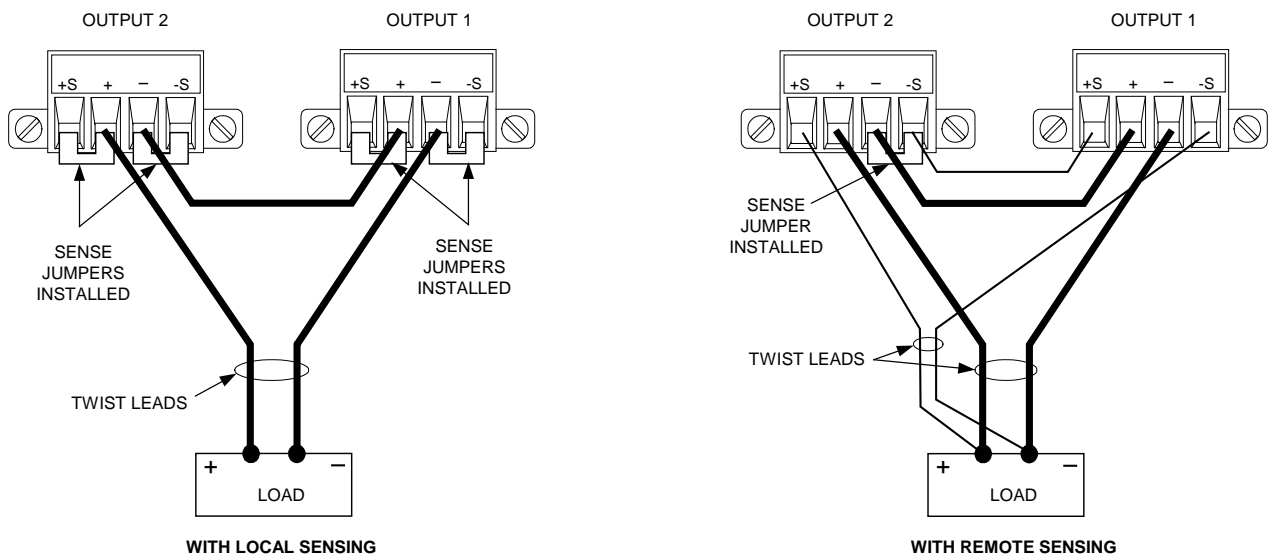

The following figure shows the connections for 50A power modules.

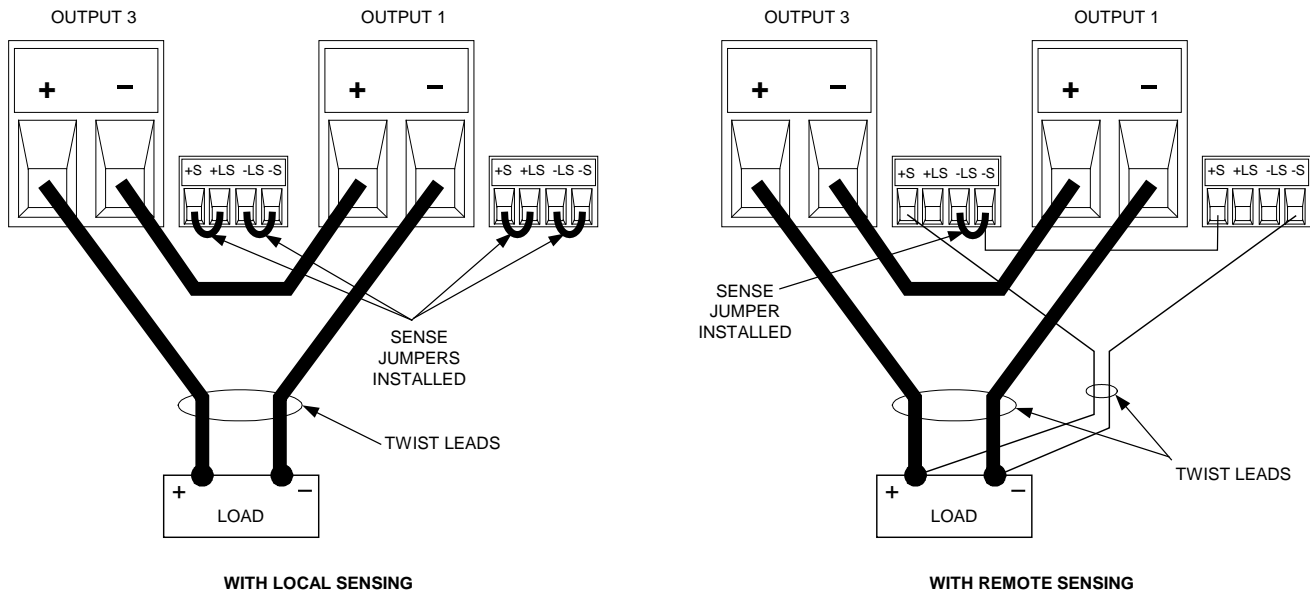

Setting the Outputs

Outputs connected together in series cannot be grouped.

To program outputs connected in series, first program the current limit of each output to the total desired current limit point. Then program the voltage of each output so that the sum of both voltages equals the total desired operating voltage. The simplest way to accomplish this is to program each output to one half of the total desired operating voltage.

NOTE

The operating mode of each output is determined by the output's programmed settings, operating point, and load condition. Because these conditions may change during series operation, the front panel status indicator will reflect these changes. This is normal. Momentary status changes are also normal.

Effect on Specifications

Specifications for outputs operating in series can be obtained from the specifications for single outputs. Most specifications are expressed as a constant or a percentage (or ppm) plus a constant. For series operation, the percentage portion remains unchanged while constant portions or any constants are changed as indicated.

Voltage All series specifications referring to voltage are twice the single output specification except for programming resolution, which is the same as for a single output.

Current All series specifications referring to current are the same as for a single output except for CC load effect, CC load cross regulation, CC source effect, and CC short term drift. These are twice the current programming accuracy (including the percentage portion) at all operating points.

Load Transient Recovery Time Load transient specifications are typically twice the single output.

Additional Load Considerations

Response Time with an External Capacitor

When programming with an external capacitor, voltage response time may be longer than that for purely resistive loads. Use the following formula to estimate the additional up-programming response time:

$$\text{Response Time} = \frac{(\text{Added Output Capacitor}) \times (\text{Change in Vout})}{(\text{Current Limit Setting}) - (\text{Load Current})}$$

Note that programming into an external output capacitor may cause the power system to briefly enter constant current or constant power operating mode, which adds additional time to the estimation.

Positive and Negative Voltages

Either positive or negative voltages with respect to ground can be obtained from the output by grounding (or "commoning") one of the output terminals. Always use two wires to connect the load to the output regardless of where or how the system is grounded. The instrument can be operated with any output terminal ± 240 VDC including output voltage from ground.

NOTE

Agilent Models N678xA SMU are optimized for grounding the negative output terminal. Grounding the positive terminal may result in increased current measurement noise and a reduction in current measurement accuracy.

Protecting Sensitive Loads from AC Power Switching Transients

NOTE

This only applies if you are connecting loads that are highly sensitive to voltage or current transients to the output of the power system. If your load is connected directly to the output of the power system and is not connected to chassis ground in any way, you do not need to worry about AC power switching transients appearing at the output of the power system.

Operating the AC line switch can inject common mode current spikes into the DC output leads, resulting in voltage spikes that may damage loads that are highly sensitive to voltage or current transients. Note that any electronic device meeting international standards for EMI compliance is likely to generate similar current spikes. This situation arises from the presence of EMI filters at both the AC input and the DC output. These filters typically include common mode capacitors connected to the chassis of the power system. Since the AC input has an earth ground, any load that is also earth-grounded provides a possible return path for common mode currents.

The following figure illustrates a typical situation where a load that might otherwise be floating becomes grounded, thereby providing a return path for any injected currents. In this case, the return path is

created by the low side of the scope probe, which is connected to the load circuit common and also to the scope's chassis. For this and similar cases, the following steps by order of preference, will help mitigate common mode current spikes appearing at the output when the power system is turned on or off by the AC line switch:

- 1 Install the ferrite core on the power cord as described under "Snap-On Core". This inserts impedance in the current path.
- 2 Install a separate "bonding" wire from the load's common point, to the ground terminal of the power system. This provides a lower impedance path that helps direct injected currents away from the DC output leads (and the sensitive load).
- 3 Break the return path through the external equipment. For example, instead of the single-ended scope shown in the figure, you can use a differential scope with a floating input or you can connect an isolated measuring instrument to the load.

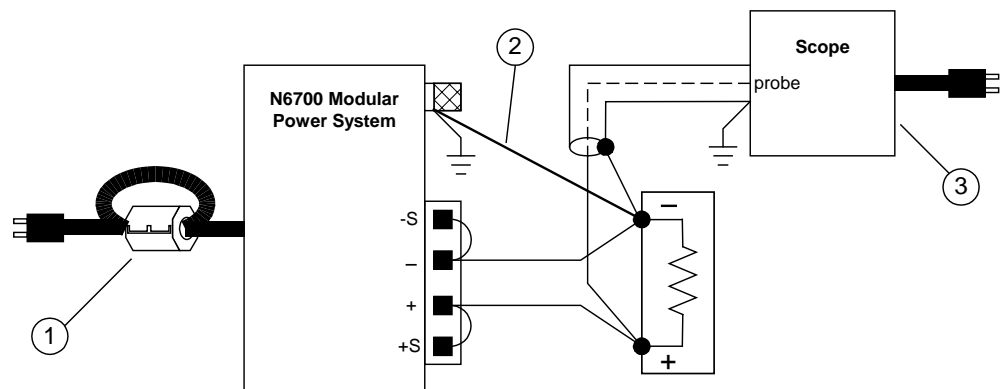
**NOTE**

Disconnecting the load from the output *before* switching the power system on or off will **always** protect the load from common mode currents.

Agilent N6781A Auxiliary Voltage Measurement Input

The auxiliary voltage measurement input is located on the rear panel of the Agilent N6781A. It is primarily used for battery voltage rundown measurements, but it is also suitable for general purpose DC measurements between ± 20 VDC. As shown in the following figure, auxiliary voltage measurements cannot be made on test points that are at a greater potential than ± 20 VDC from Common.

Refer to chapter 4 under “Making Measurements” for more information.

CAUTION

When using the auxiliary voltage measurement input on Model N6781A, no output terminal or measurement input terminal may be more than ± 60 VDC from any other terminal and chassis ground.

A. AUX Voltage Measurement inputs

B. Test Fixture

1. 36 V
2. 24 V
3. 12 V
4. Com.
5. -12 V
6. -24 V
7. -36 V

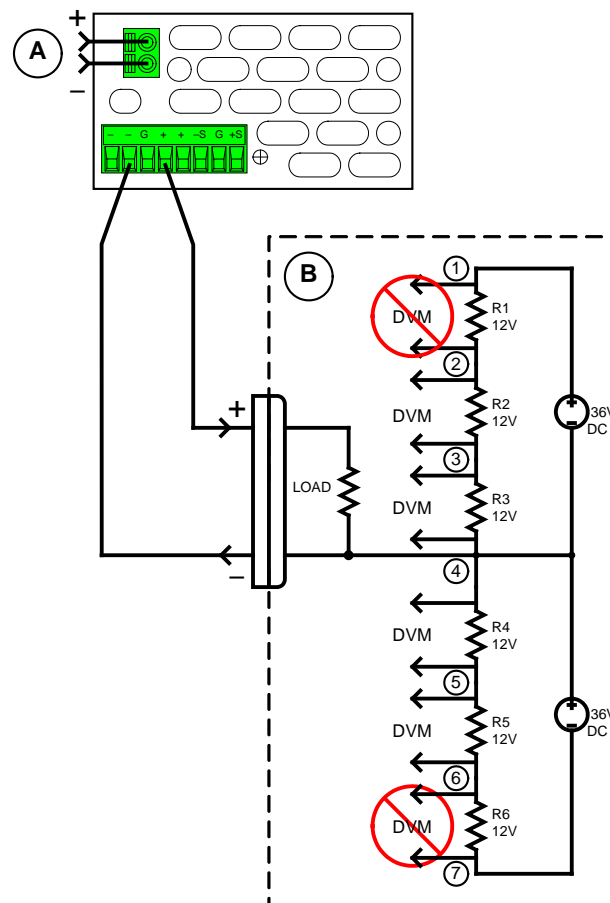

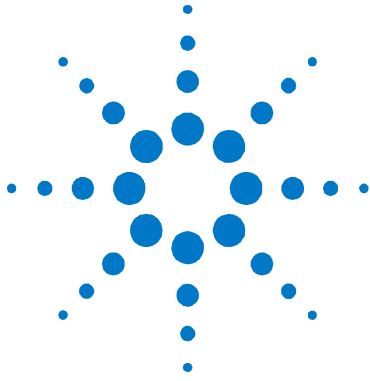

3

Getting Started

Turning the Unit On	46
Selecting an Output Channel	46
Entering an Output Voltage Setting	46
Entering a Current Limit Setting	47
Enabling the Output	47
Using the Front Panel Menu	48
Connecting to the Interfaces	50
Communicating Over the LAN	57
Securing the Interfaces	59

This chapter describes how to get started using your power system. It discusses turning the unit on, using the front panel controls, and navigating the front panel command menu. A map of the front panel menu structure is found in Chapter 1.

This chapter also contains information on how to configure the three remote interfaces that are provided on the back of the instrument.

NOTE

Detailed information on configuring the remote interfaces is included in the Agilent Technologies *USB/LAN/GPIB Interfaces Connectivity Guide*, which is available on the Automation-Ready CD included with this product.

Turning the Unit On

After you have connected the line cord, turn the unit on with the front panel power switch. The front panel display will light up after a few seconds.

A *power-on* self-test occurs automatically when you turn the unit on. This test assures you that the instrument is operational. If the self-test fails, the front panel **Err** indicator comes on. Press the Error key to display the list of errors on the front panel. Refer to the Service Guide for further information.

When the front panel display appears, you can use the front panel controls to enter voltage and current values.

Selecting an Output Channel

Channel

Press the **Channel** key to select the output channel that you wish to program.

Entering an Output Voltage Setting

Method 1 – Use the Navigation and Arrow Keys

Navigation Keys

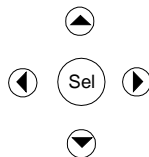

Use the left and right navigation keys to navigate to the setting that you wish to change. In the display below, channel 1's voltage setting is selected. Enter a value using the numeric keypad. Then press Enter.



Arrow Keys



You can also use the arrow keys to adjust the value up or down, and switch between + and – limits on Model N6784A. When the output is on and the unit is operating in CV mode, the output voltage changes immediately. Otherwise, the value will become effective when the output is turned on.

Method 2 - Use the Voltage key to enter a value

Voltage

Use the **Voltage** key to select the voltage entry field. In the display below, channel 1's voltage setting is selected. Enter the desired setting using the numeric keypad. Then press Enter.

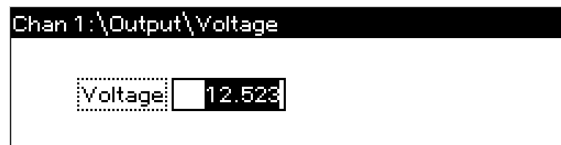

NOTE

If you make a mistake, either use the **←** backspace key to delete the number, press **Back** to back out of the menu, or press **Meter** to return to meter mode.

Entering a Current Limit Setting

Method 1 – Use the Navigation and Arrow Keys

Navigation Keys

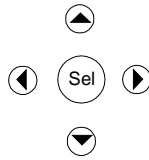

Use the left and right navigation keys to navigate to the setting that you wish to change. In the display below, channel 1's current setting is selected. Enter a value using the numeric keypad. Then press Enter.



Arrow Keys



You can also use the arrow keys to adjust the value up or down and switch between + and – limits on Models N678xA SMU. When the output is on and the unit is operating in CC mode, the output current changes immediately. Otherwise, the value will become effective when the output is turned on.

Method 2 - Use the Current key to enter a value

Current

Use the **Current** key to select the current entry field. In the display below, channel 1's current setting is selected. Enter the desired setting using the numeric keypad. Then press Enter.

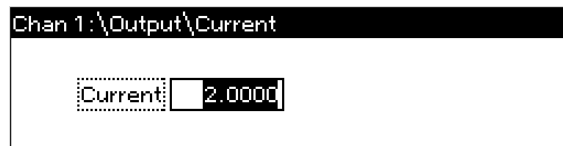

NOTE

If you make a mistake, either use the ◀ backspace key to delete the number, press **Back** to back out of the menu, or press **Meter** to return to meter mode.

Enabling the Output

Use the On/Off key to enable the output

On/Off

If a load is connected to the output, the front panel display will indicate that it is drawing current. Otherwise, the current reading will be zero. The status indicator next to the channel number indicates the output's status. In this case, the output channel is in constant voltage mode.



NOTE

For a description of the status indicators, refer to Chapter 1, under "Front Panel Display – At a Glance".

Using the Front Panel Menu

The front panel command menu lets you access most of the power system's functions. The actual function controls are located at the lowest menu level. Briefly:

- Press the **Menu** key to access the command menu.
- Press the navigation keys to move across the menu commands.
- Press the center (**Sel**) key to select a command and move down to the next level in the menu.
- Press the **Help** key at the lowest menu level to display help information about the function controls.

A map of the front panel command structure is found in Chapter 1. The following example shows you how to navigate the front panel command menu to program the over-voltage protection function.

Set the Over-Voltage Protection

The over-voltage protection function turns off the affected output if the output voltage reaches the programmed over-voltage limit.

Menu

Press the **Menu** key to access the front panel command menu.

The first line identifies the output channel that is being controlled followed by the menu path. Since the top level is displayed, the path is empty.

The second line indicates the commands that are available at the present menu level. In this case, the top-level menu commands are shown, with the Output command highlighted.

The third line indicates which commands are available under the Output command. Selecting the highlighted command accesses this lower level.

```
Chan 1:\
Output Measure Transient Protect States System
Voltage, Current, Mode, Sequence, Advanced
```

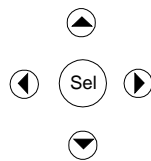

Press the right arrow ► navigation key to traverse the menu until the Protect command is highlighted. Press the **Sel** key to select the Protect command.

```
Chan 1:\
Output Measure Transient Protect States System
OVP, OCP, Inhibit, Coupling, WDog, Osc, Clear
```

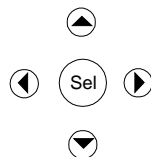

The menu path now shows that the commands shown on the second line are located under the Protect command. The OVP command is highlighted. The third line indicates which functions are located under the OVP command.

Press the **Sel** key to select the OVP command.

```
Chan 1:\Protect
OVP OCP Inhibit Coupling WDog Osc Clear
Overvoltage protection settings.
```

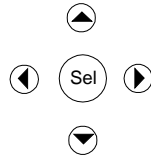



4 4 Enter

Channel

The command menu is now at the function control level. This is the lowest level in this path.

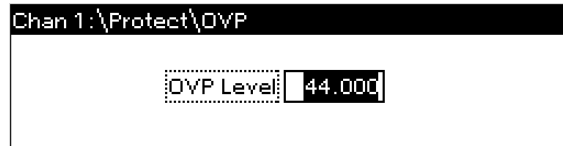
Use the navigation keys to highlight the OVP Level control as shown below. Enter the desired over-voltage level using the numeric keypad. Then press Enter.



Press the **Channel** key at any time to select a different output channel. This can save time because you can directly access the OVP control of each channel without having to navigate through the menu levels.

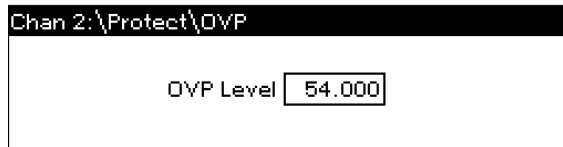

NOTE

If you program an over-voltage protection level that is lower than the present output voltage, the over-voltage protection circuit will trip and turn the output channel off. The front panel status indicator will show OV.

Exiting the Command Menu

There are two ways to exit the command menu.

Meter

Press the **Meter** key to immediately return to the metering screen. This is the quickest way to return to metering mode.

Back

Press the **Back** key to back up one level at a time in the command menu. This method may be more convenient if there are other menu commands to be given.

Detailed instructions on how to use the power system's functions and capabilities are found in the next chapter. Detailed information about the SCPI programming commands are found in the Programmer's Reference Help file on your Agilent N6700 Product Reference CD.

In Case of Trouble

Press the Help key to obtain additional help about any function control menu level. Press the Back key to exit the Help menu.

The front panel **Err** indicator comes on if self-test fails or if other operating problems occur with your instrument. Press the Error key to display the list of errors. Refer to the N6700 Service Guide for further information.

The N6700 Service Guide is included as part of the optional Manual Set (Option 0L1). An electronic copy of the N6700 Service Guide is also included on the N6700 Product Reference CD-ROM.

Connecting to the Interfaces

The Agilent N6700 MPS supports GPIB, LAN, and USB interfaces. All three interfaces are live at power-on. Connect your interface cable to the appropriate interface connector. Information on configuring the interfaces is found later in this chapter.

The front panel **IO** indicator comes on whenever there is activity on the remote interfaces. The front panel **Lan** indicator comes on when the LAN port is connected and configured.

Power system mainframes provide Ethernet connection monitoring. With Ethernet connection monitoring, the instrument's LAN port is continually monitored, and automatically reconfigured when the instrument is unplugged for a minimum of 20 seconds and then reconnected to a network.

GPIB Interface

NOTE

For detailed information about GPIB interface connections, refer to the Agilent Technologies *USB/LAN/GPIB Interfaces Connectivity Guide*, located on the Automation-Ready CD that is shipped with your product.

The following steps will help you quickly get started connecting your instrument to the General Purpose Interface Bus (GPIB). The following figure illustrates a typical GPIB interface system.

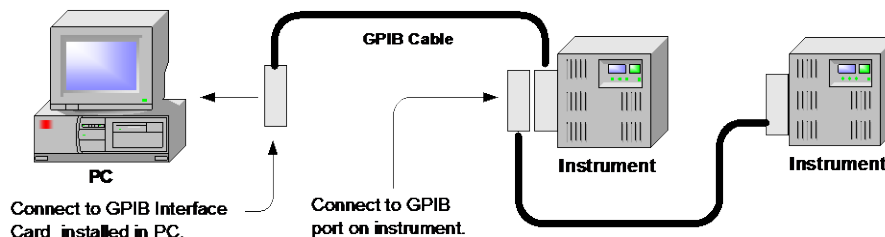

- 1 If you have not already done so, install the Agilent IO Libraries Suite from the Automation-Ready CD that is shipped with your product.
- 2 If you do not have a GPIB interface card installed on your computer, turn off your computer and install the GPIB card.
- 3 Connect your instrument to the GPIB interface card using a GPIB interface cable.
- 4 Use the Connection Expert utility of the Agilent IO Libraries Suite to configure the installed GPIB interface card's parameters.
- 5 The power system is shipped with its GPIB address set to 5. Use the front panel menu if you need to change the GPIB address.
 - a Press the Menu key, then use the navigation keys to select **System\IO\GPIB**.
 - b Use the numeric keys to enter a new value. Valid addresses are from 0 to 30. Press the Enter key to enter the value. Press the Meter key to exit the menu.

- 6 You can now use Interactive IO within the Connection Expert to communicate with your instrument, or you can program your instrument using the various programming environments.

USB Interface

NOTE

For detailed information about USB interface connections, refer to the Agilent Technologies *USB/LAN/GPIB Interfaces Connectivity Guide*, located on the Automation-Ready CD that is shipped with your product.

The following steps will help you quickly get started connecting your USB-enabled instrument to the Universal Serial Bus (USB). The following figure illustrates a typical USB interface system.

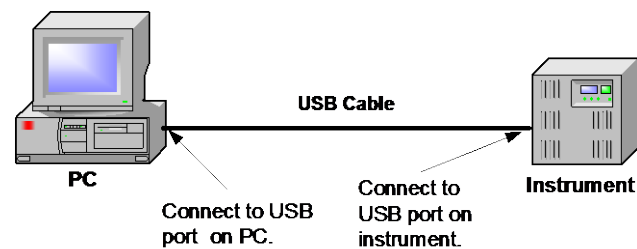

- 1 If you have not already done so, install the Agilent IO Libraries Suite from the Automation-Ready CD that is shipped with your product.
- 2 Connect your instrument to the USB port on your computer.
- 3 With the Connection Expert utility of the Agilent IO Libraries Suite running, the computer will automatically recognize the instrument. This may take several seconds. When the instrument is recognized, your computer will display the VISA alias, IDN string, and VISA address. This information is located in the USB folder.
- 4 Note that you can also view the instrument's VISA address from the front panel. Press the Menu key, then use the navigation keys to select **System\IO\USB\Identification**.
- 5 You can now use Interactive IO within the Connection Expert to communicate with your instrument, or you can program your instrument using the various programming environments.

LAN Interface

NOTE

For detailed information about LAN interface connections, refer to the Agilent Technologies *USB/LAN/GPIB Interfaces Connectivity Guide*, located on the Automation-Ready CD that is shipped with your product.

The following steps will help you quickly get started connecting and configuring your instrument on a local area network. The two types of local area networks connections that are discussed in this section are site networks and private networks.

Connecting to a Site LAN

A site LAN is a local area network in which LAN-enabled instruments and computers are connected to the network through routers, hubs, and/or switches. They are typically large, centrally-managed networks with services such as DHCP and DNS servers.

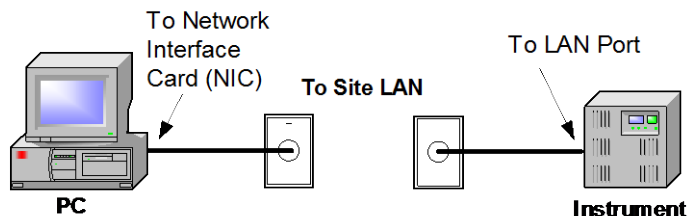

- 1 If you have not already done so, install the Agilent IO Libraries Suite from the Automation-Ready CD that is shipped with your product.
- 2 Connect the instrument to the site LAN. The factory-shipped instrument LAN settings are configured to automatically obtain an IP address from the network using a DHCP server (DHCP is set On). Note that this may take up to one minute. The DHCP server will register the instrument's hostname with the dynamic DNS server. The hostname as well as the IP address can then be used to communicate with the instrument. The front panel **Lan** indicator will come on when the LAN port has been configured.

NOTE

If you need to manually configure any instrument LAN settings, refer to "Configuring the LAN Parameters" later in this chapter for information about configuring the LAN settings from the front panel of the instrument.

- 3 Use the Connection Expert utility of the Agilent IO Libraries Suite to add the N6700 power system and verify a connection. To add the instrument, you can request the Connection Expert to discover the instrument. If the instrument cannot be found, add the instrument using the instrument's hostname or IP address.

NOTE

If this does not work, refer to the chapter on "Troubleshooting Guidelines" in the Agilent Technologies *USB/LAN/GPIB Interfaces Connectivity Guide*.

- 4 You can now use Interactive IO within the Connection Expert to communicate with your instrument, or you can program your instrument using the various programming environments. You can also use the Web browser on your computer to communicate with the instrument as described under "Using the Web Server" later in this chapter.

Connecting to a Private LAN

A private LAN is a network in which LAN-enabled instruments and computers are directly connected, and not connected to a site LAN. They are typically small, with no centrally-managed resources.

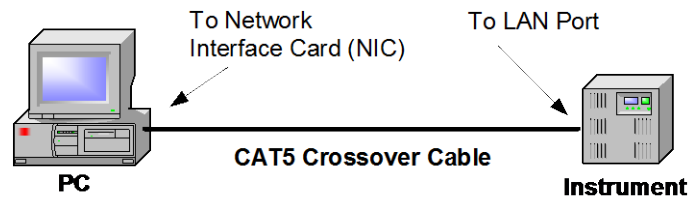

- 1 If you have not already done so, install the Agilent IO Libraries Suite from the Automation-Ready CD that is shipped with your product.
- 2 Connect the instrument to the computer using a LAN crossover cable. Alternatively, connect the computer and the instrument to a standalone hub or switch using regular LAN cables.

NOTE

Make sure your computer is configured to obtain its address from DHCP and that NetBIOS over TCP/IP is enabled. Note that if the computer had been connected to a site LAN, it may still retain previous network settings from the site LAN. Wait one minute after disconnecting it from the site LAN before connecting it to the private LAN. This allows Windows to sense that it is on a different network and restart the network configuration. If you are running Windows 98, you may need to manually release the previous settings.

- 3 The factory-shipped instrument LAN settings are configured to automatically obtain an IP address from a site network using a DHCP server. You can leave these settings as they are. Most Agilent products and most computers will automatically choose an IP address using auto-IP if a DHCP server is not present. Each assigns itself an IP address from the block 169.254.nnn. Note that this may take up to one minute. The front panel **Lan** indicator will come on when the LAN port has been configured.

NOTE

Turning off DHCP reduces the time required to fully configure a network connection when the power system is turned on. To manually configure the instrument LAN settings, refer to “Configuring the LAN Parameters” later in this chapter.

- 4 Use the Connection Expert utility of the Agilent IO Libraries Suite to add the N6700 power system and verify a connection. To add the instrument, you can request the Connection Expert to discover the instrument. If the instrument cannot be found, add the instrument using the instrument’s hostname or IP address.

NOTE

If this does not work, refer to the chapter on “Troubleshooting Guidelines” in the Agilent Technologies *USB/LAN/GPIB Interfaces Connectivity Guide*.

- 5 You can now use Interactive IO within the Connection Expert to communicate with your instrument, or you can program your instrument using the various programming environments. You can also use the Web browser on your computer to communicate with the instrument as described under “Using the Web Server” later in this chapter.

Viewing the Active LAN Settings

To view the currently active LAN settings, press the Menu key, then use the navigation keys to select: **System\IO\LAN\ActiveSettings**.

The currently active settings for the IP Address, Subnet Mask, and Default Gateway may be different from the front panel configuration menu settings - depending on the configuration of the network. If the settings are different, it is because the network has automatically assigned its own settings.

Modifying the LAN Settings

NOTE

The power system must be rebooted for any LAN setting modifications to take effect.

As shipped from the factory, the power system's pre-configured settings should work in most LAN environments. If you need to manually configure these settings, press the Menu key, then use the navigation keys to select: **System\IO\LAN\Config**.

In the **Config** menu you can then select from the following items: IP, Name, Domain, DNS, TCP, and Reset. Note that the **Reset** command resets the LAN settings to the factory-shipped state.

IP

Select **IP** to configure the addressing of the instrument. The configurable parameters include:

- Automatic** This parameter automatically configures the addressing of the instrument. When selected, the instrument will first try to obtain an IP address from a DHCP server. If a DHCP server is found, the DHCP server will assign an IP address, Subnet Mask, and Default Gateway to the instrument. If a DHCP server is unavailable, the instrument will try to obtain an IP address using AutoIP. AutoIP automatically assigns an IP address, Subnet Mask, and Default Gateway addresses on networks that do not have a DHCP server.
- Manual** This parameter allows you to manually configure the addressing of the instrument by entering values in the following three fields. These fields only appear when Manual is selected.
- IP Address** This value is the Internet Protocol (IP) address of the instrument. An IP address is required for all IP and TCP/IP communications with the instrument. An IP Address consists of 4 decimal numbers separated by periods. Each decimal number ranges from 0 through 255.
- Subnet Mask** This value is used to enable the instrument to determine if a client IP address is on the same local subnet. When a client IP address is on a different subnet, all packets must be sent to the Default Gateway.

Default Gateway This value is the IP Address of the default gateway that allows the instrument to communicate with systems that are not on the local subnet, as determined by the subnet mask setting. A value of 0.0.0.0 indicates that no default gateway is defined.

Name

Select **Name** to configure the hostname of the instrument. If you want to change the hostname, you should do so before you connect the instrument to the network. Otherwise, the original hostname may be cached in the network for up to several hours.

Host name This field registers the supplied name with the selected naming service. If the field is left blank, no name is registered. A hostname may contain upper and lower case letters, numbers and dashes(-). The maximum length is 15 characters. Use the navigation keys to enter an alpha character. Use the up/down navigation or arrow keys to select a letter from the alphabetic choices as you scroll through the selections. Use the number keys to enter a number.

Each power system is shipped with a default hostname with the format: A-modelnumber-serialnumber, where *modelnumber* is the mainframe's 6-character model number (e.g. N6700B), and *serialnumber* is the last five characters of the 10-character mainframe serial number located on the label on the top of the unit (e.g. 45678 if the serial number is MY12345678). A-N6700B-45678 is an example of a hostname.

Use Dynamic DNS naming service Registers the hostname using the Dynamic DNS naming system.

Use NetBIOS naming service Registers the hostname using the RFC NetBIOS naming protocol.

Domain

Select **Domain** if your DNS server requires an instrument to register not only the hostname, but also the domain name.

Domain name Registers the Internet domain for the instrument. The Domain must start with a letter and may contain upper and lower case letters, numbers, dashes(-) and dots(.). Use the navigation keys to enter an alpha character. Use the up/down navigation or arrow keys to select a letter from the alphabetic choices as you scroll through the selections. Use the number keys to enter a number.

DNS

Select **DNS** to configure the Domain Name System (DNS) setup of the instrument. DNS is an internet service that translates domain names into IP addresses. It is also needed for the instrument to find and display its hostname assigned by the network.

- Obtain DNS server from DHCP** Select this item to obtain the DNS server address from DHCP. You must have enabled DHCP in the IP menu.
- Use the following DNS server** Select this item if you are not using DHCP or need to connect to a specific DNS server.
- DNS Server** This value is the address of the DNS server. It is used if you are not using DHCP or if you need to connect to a specific DNS server.

NOTE

For improved performance when connected to an isolated subnet, select **Use the following DNS server**. However, leave the **DNS server** address field blank.

TCP

Select **TCP** to configure the TCP keepalive settings of the instrument.

- Enable TCP Keepalive** Check the Enable box to enable the TCP keepalive function. The instrument uses the TCP keepalive timer to determine if a client is still reachable. If there has been no activity on the connection after the specified time, the instrument will send keepalive probes to the client to determine if it is still alive. If not, the connection will be marked as down or "dropped." The instrument will release any resources that were allocated to that client.
- TCP keepalive timeout** This is the delay in seconds before TCP keepalive probes will be sent to the client. It is recommended that the largest value be used that still meets the application's need for unreachable client detection. Smaller keepalive timeout values will generate more keepalive probes (network traffic), using more of the available network bandwidth. Allowed values: 720 - 99999 seconds.

Reset

Resets the LAN settings to the factory-shipped state. These settings are listed at the end of this chapter.

Communicating Over the LAN

The Agilent IO Libraries Suite along with instrument drivers for specific programming environments can be used to communicate with your power system. You can also communicate with your power system using its built-in Web server, the Telnet utility, or sockets. These latter methods are a convenient way to communicate with the power system without using I/O libraries or drivers. In all cases, you must first establish a LAN connection from your computer to the power system as previously discussed.

Using the Web Server

Your power system has a built-in Web server that lets you control it directly from an internet browser on your computer. With the Web server, you can access the front panel control functions including the LAN configuration parameters. Up to **two** simultaneous connections are allowed. With additional connections, performance will be reduced.

NOTE

The built-in Web server only operates over the LAN interface. It requires Internet Explorer 7+ or Firefox2+. You also need the Java (Sun) Plug-in. This is included in the Java Runtime Environment. Refer to Sun Microsystem's website. If you are using Internet Explorer 7 open a separate browser window for each connection.

The Web server is enabled when shipped. To launch the Web server:

- 1 Open the internet browser on your computer.
- 2 Enter the instrument's hostname or IP address into the browser's Address field to launch the Web server. The following home page will appear:

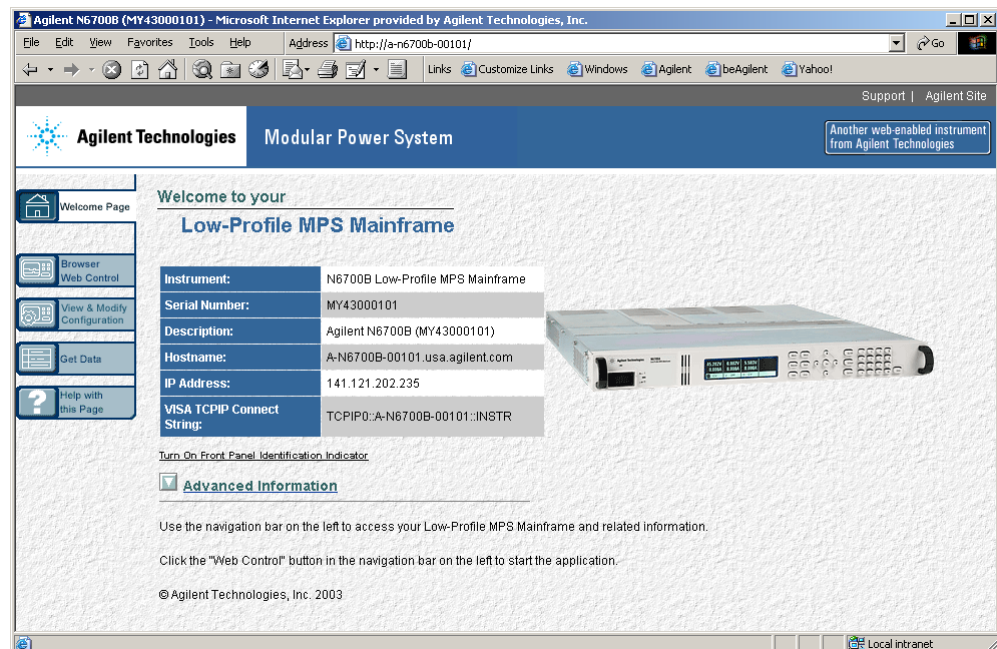

- 3 Click on the Browser Web Control button in the navigation bar on the left to begin controlling your instrument.
- 4 For additional help about any of the pages, click on the Help with this Page button.

If desired, you can control access to the Web server using password protection. As shipped from the factory, no password is set. To set a password, click on the View & Modify Configuration button. Refer to the on-line help for additional information about setting a password.

Using Telnet

In an MS-DOS Command Prompt box type: *telnet hostname 5024* where *hostname* is the N6700 hostname or IP address, and 5024 is the instrument's telnet port.

You should get a Telnet session box with a title indicating that you are connected to the power system. Type the SCPI commands at the prompt.

Using Sockets

NOTE

Power system mainframes allow any combination of up to **four** simultaneous data socket, control socket, and telnet connections to be made.

Agilent instruments have standardized on using port 5025 for SCPI socket services. A **data socket** on this port can be used to send and receive ASCII/SCPI commands, queries, and query responses. All commands must be terminated with a newline for the message to be parsed. All query responses will also be terminated with a newline.

The socket programming interface also allows a **control socket** connection. The control socket can be used by a client to send device clear and to receive service requests. Unlike the data socket, which uses a fixed port number, the port number for a control socket varies and must be obtained by sending the following SCPI query to the data socket: `SYSTem:COMMunicate:TCPIP:CONTRol?`

After the port number is obtained, a control socket connection can be opened. As with the data socket, all commands to the control socket must be terminated with a newline, and all query responses returned on the control socket will be terminated with a newline.

To send a device clear, send the string "DCL" to the control socket. When the power system has finished performing the device clear it echoes the string "DCL" back to the control socket.

Service requests are enabled for control sockets using the Service Request Enable register. Once service requests have been enabled, the client program listens on the control connection. When SRQ goes true the instrument will send the string "SRQ +nn" to the client. The "nn" is the status byte value, which the client can use to determine the source of the service request.

Securing the Interfaces

Enable/Disable the USB, LAN, and Web Server

The USB interface, LAN interface, and the Web server are enabled when shipped.

To enable or disable the USB interface from the front panel, press the Menu key and select **System\Admin\USB**.

- Enable USB** Check this box to enable the USB.
 Uncheck this box to disable the USB.

To enable or disable the LAN interface or Web server, press the Menu key and select the following menu commands: **System\Admin\LAN**.

- Enable LAN** Check this box to enable the LAN. Uncheck this box to disable the LAN.
- Enable Web Server** Check this box to enable the Web server. Uncheck this box to disable the Web server. The LAN must be enabled in order to enable the Web server.

If you cannot access the Admin menu, it may be password protected.

Password-Protecting the Interfaces, Factory Settings, and Calibration

You can password-protect access to the LAN and USB interfaces as well as the non-volatile RAM reset and the calibration functions. This capability is available in the **System\Admin** menu.

As shipped from the factory, the Admin menu password is 0 (zero). This means that you do not have to enter a password to access the Admin menu. Simply select **System\Admin>Login** and press Enter.

To password-protect the Admin menu, select **System\Admin>Password**. The password must be numeric, and up to 15 digits long. When done, log out of the Admin menu to activate the password. You can now only enter the Admin menu by providing the right password.

If the password is lost, access can be restored by setting an internal switch to reset the password to 0. If the message “Locked out by internal switch setting” or “Calibration is inhibited by switch setting” appears, the internal switch is set to prevent the password from being changed (Refer to the Service Guide).

Restoring the Non-volatile Factory Settings

Remote interface settings are stored in non-volatile memory. The factory-shipped interface settings documented in the following table are optimized for connecting your power system to a site network. They should also work well for other network configurations.

These factory-shipped LAN settings can be restored by selecting the Reset control in the **System\IO\LAN\Config\Reset** menu.

All non-volatile settings including LAN, can be restored by selecting the Reset control located in the **System\Admin\Nvram** menu.

Factory-shipped non-volatile LAN settings			
Get IP Address	Automatic	Dynamic DNS naming service	Enabled
IP Address	169.254.67.0	NetBIOS naming service	Enabled
Subnet Mask	255.255.0.0	Domain name	Blank
Default Gateway	0.0.0.0	TCP keepalive	Enabled
Obtain DNS server from DHCP	Enabled	TCP keepalive seconds	1800
DNS server	Blank	Ethernet Auto-negotiation	Enabled
Host name	A-N67xxx-xxxxx	Ping server	Enabled
		Web password	Blank

Other factory-shipped non-volatile settings			
Admin/Calibration password	0 (zero)	On/Off key affects all channels	Disabled
Calibration date	March 5, 2003	Output Inhibit mode	Off
Channel grouping	No groups	Saved states	*RST command
Digital port function (all pins)	Digital In	Screen contrast	50%
Digital port polarity (all pins)	Positive	Screen saver	Enabled
Front panel lockout	Disabled	Screen saver delay	60 minutes
Front panel meter view	1-channel	USB interface	Enabled
GPIB Address	5	Wake on I/O	Enabled
Key clicks	Enabled	Web server	Enabled
LAN interface	Enabled		

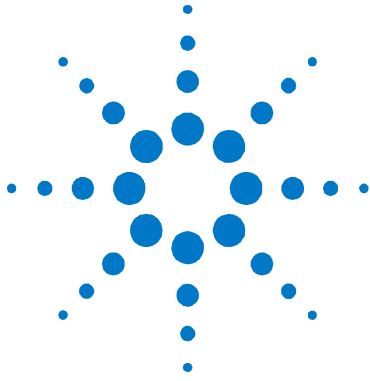

4 Operating the Power System

Programming the Output	62
Synchronizing Output Steps	68
Programming Output Lists	72
Making Measurements	77
Using the Digitizer	79
Using the Protection Functions	87
External Data Logging	91
System-Related Operations	95

This chapter contains examples on how to operate your power system from the front panel and over the remote interface using SCPI commands.

For complete details on the SCPI (Standard Commands for Programmable Instruments) commands, refer to the Programmer's Reference Help file included on the Agilent N6700 Product Reference CD. This CD-ROM is shipped along with your instrument.

The simple examples discussed in this chapter show you how to program:

- Output voltage and current functions
- Output triggers
- Measurement functions
- Measurement triggers
- Protection functions
- System functions

Refer to Appendix B for information about using the Digital Port on the back of your instrument.

Refer to Appendix C for information about using the power allocation function.

Programming the Output

Select a Channel View

Front Panel:	SCPI Command:
Press the Meter key to toggle between single-channel and multiple-channel view.	To select single-channel view: DISP:VIEW METER1 To set multiple-channel view: DISP:VIEW METER4

Select an Output Channel

Front Panel:	SCPI Command:
Press the Channel key to select an output channel.	Enter the selected channel(s) in the command's parameter list. OUTP:STAT? (@1, 2)

Set the Output Voltage

Front Panel:	SCPI Command:
Press the Voltage key. Enter a value and press Select.	To set output 1 to 5 V: VOLT 5, (@1) To set all outputs to 10 V: VOLT 10, (@1:4)

For models with multiple ranges, you can select a lower range if you need better output resolution.

Front Panel:	SCPI Command:
Press the Voltage key. Select a lower range and press Select.	To select the lower range, program a value that falls within the range: VOLT:RANG 5, (@1)

For Agilent Models N678xA SMU operating in current priority mode, you can specify a Voltage limit., which limits the output voltage at the specified value. In current priority mode, the output current remains at its programmed setting as long as the output voltage is within the positive or negative limit. Check Tracking to let the negative voltage limit track the positive voltage limit setting.

Front Panel:	SCPI Command:
Press the Voltage key. Specify a + Voltage limit and or a – Voltage limit and press Select. Check the Tracking box if you want the – limit to track the + limit.	To select the voltage limit: VOLT:LIM 5, (@1) To select the negative voltage limit: VOLT:LIM:NEG 3, (@1) To enable voltage limit tracking: VOLT:LIM:COUP ON, (@1)

Set the Output Current

Front Panel:	SCPI Command:
Press the Current key.	To set output 1 to 1 A: CURR 1, (@1)
Enter a value and press Select.	To set all outputs to 2 A: CURR 2, (@1 : 4)

For models with multiple ranges, you can select a lower range if you need better output resolution.

Front Panel:	SCPI Command:
Press the Current key.	To select the lower range, program a value that falls within the range:
Select a lower range and press Select.	CURR : RANG 1, (@1)

For Agilent Models N678xA SMU operating in voltage priority mode, you can specify a Current limit., which limits the output current at the specified value. In voltage priority mode, the output voltage remains at its programmed setting as long as the load current is within the positive or negative limit. Check Tracking to let the negative current limit track the positive current limit setting.

Front Panel:	SCPI Command:
Press the Current key.	To select the current limit:
Specify a + Current limit and or a – Current limit and press Select.	CURR : LIM 5, (@1)
Check the Tracking box if you want the – limit to track the + limit.	To select the negative current limit: CURR : LIM : NEG 3, (@1)
	To enable current limit tracking: CURR : LIM : COUP ON, (@1)

Set the Output Mode

NOTE

This information applies to Agilent Models N678xA SMU only.

For Agilent Models N678xA SMU, you can select either Voltage priority or Current priority mode.

In voltage priority mode the output is controlled by a bi-polar constant voltage feedback loop, which maintains the output voltage at its positive or negative programmed setting. The output voltage will remain at its programmed setting as long as the load current remains within the positive or negative current limit.

In current priority mode the output is controlled by a bi-polar constant current feedback loop, which maintains the output sourcing or sinking current at its programmed setting. The output current will remain at its programmed setting as long as the load voltage remains within the positive or negative voltage limit.

Front Panel:	SCPI Command:
Select Output\Mode . Select either Voltage priority or Current priority and press Select.	To set output 1 to current priority: FUNC CURR , (@1)

NOTE

When switching between Voltage priority and Current priority, the output is turned off and the output settings revert to their Power-on or RST values. Refer to Appendix E for information about voltage and current priority mode operation.

Set the Slew Rate

Front Panel:	SCPI Command:
Select Output\Advanced\Slew Then select Voltage or Current	To set the voltage slew rate to 5 V/s VOLT:SLEW 5 , (@1)
Enter the voltage or current slew rate in the Slew Rate field.	To set the current slew rate to 1 A/s CURR:SLEW 1 , (@1)
Check Max slew rate to program the fastest slew rate.	To set the fastest slew rate: VOLT:SLEW MAX , (@1)

The voltage slew rate determines the rate at which the voltage changes to a new programmed setting. When set to MAXimum, INfinity, or to a very large value, the slew rate will be limited by the analog performance of the output circuit. The slowest or minimum slew rate is model-dependent and is a function of the full scale range. For other ranges the minimum slew rate is proportional to the full scale range.

The current slew rate control is only available on Agilent Models N678xA SMU. It determines the rate at which the current changes to a new programmed setting. When set to MAXimum, INfinity, or to a very large value, the slew rate will be limited by the analog performance of the output circuit. The slowest or minimum slew rate is model-dependent and is a function of the full scale range. For other ranges the minimum slew rate is proportional to the full scale range.

Enable the Output

Front Panel:	SCPI Command:
Press the On/Off key.	To enable only output 1: OUTP ON , (@1)
To enable/disable ALL outputs using the On/Off key, select System\Preferences\Keys . Check On/Off affects all channels.	To enable outputs 1-4: OUTP ON , (@1 : 4)

Because of internal circuit start-up procedures and any installed relay options, output on may take between 35 and 50 milliseconds to complete its function. Conversely, output off may take between 20 and 25 milliseconds to complete its function.

To mitigate these built-in delays, you can program the output to zero volts rather than using the output on/off function.

Sequence Multiple Outputs

Turn-on and turn-off delays control the power-up and power-down sequencing of the output channels in relation to each other.

Front Panel:	SCPI Command:
Press the Channel key to select an output. Then select Output\Sequence\Delay .	To program a 50 millisecond turn-on delay for output 1 and a 100 millisecond turn-on delay for output 2:
Select either Turn-on or Turn-off.	<code>OUTP:DEL:RISE .05,(@1)</code>
Enter a delay in seconds, then press Select.	<code>OUTP:DEL:RISE .1,(@2)</code>
Select System\Preferences\Keys .	To program a 200 millisecond turn-off delay for outputs 3 and 4:
Check On/Off affects all channels.	<code>OUTP:DEL:FALL .2,(@3,4)</code>

Output turn-on characteristics vary across the power module types - DC Power, Autoranging, Precision, and Source/Measure. When output channels of the **same** module type are programmed off-to-on, output sequencing is determined by the programmed turn-on delays.

When outputs of **different** module types are sequenced, there may be additional offsets of a few milliseconds from one output to another that must be accounted for. Specifying a common delay offset assures that the programmed turn-on delays will be synchronized to start at the completion of the common delay offset. Select the delay offset of the *slowest* power module in the mainframe and use that as the common delay offset. (See Appendix D for more information.)

Front Panel:	SCPI Command:
In the front panel menu, select Output\Sequence\Couple .	To query the delay offset of the <i>slowest</i> power module in the mainframe (the maximum delay offset) in seconds:
The Max delay offset for this frame field displays the delay offset of the <i>slowest</i> power module in the frame.	<code>OUTP:COUP:MAX:DOFF?</code>
Enter this value into the Delay offset field in milliseconds; then press Select.	To specify the common delay offset for the mainframe in seconds: <code>OUTP:COUP:DOFF .051</code>

Program the Output Relays

Output relay availability and options are described in Chapter 1 under “Model Differences”. Option 761 provides double-pole, double-throw relays that disconnect both the output and sense terminals. Option 760 is the same as option 761 but adds output reversal relays. Note that a small AC network is always present across the output terminals.

If you have Option 761 installed, the normal operating mode of the relay is to open and close as the output is turned on or off. The relays are only opened or closed when the output is at a safe state (zero voltage; zero current). Note however, that you can program the output state on or off while leaving the relay state unchanged.

Front Panel:	SCPI Command:
Not Available	To leave the relays closed when output 1 is turned off: OUTP OFF,NOR, (@1)
	To leave the relays open when output 1 is turned on: OUTP ON,NOR, (@1)

If you have Option 760 installed, you can also reverse the polarity of the output and sense terminals. Note that this command briefly turns the output off while the output and sense terminal polarities are switched. Also note that if this option is installed in Model N6742B, the maximum output current will be limited to 10A.

Front Panel:	SCPI Command:
Select Output\Advanced\Pol. Then check the Reverse box.	To switch the output and sense terminal polarities of output 1: OUTP:REL:POL REV, (@1)
Uncheck the Reverse box to return the polarity to normal.	To return the polarities back to normal: OUTP:REL:POL NORM, (@1)

NOTE

When the output polarity has been reversed, the voltage meter on the front panel display will show a bar over the voltage reading: 10.001V

Set the Agilent N6781A Output Resistance

NOTE

This information applies to Agilent Model N6781A only.

Output resistance programming is primarily used in battery testing applications, and only applies in Voltage priority mode. Values are programmed in Ohms, from $-40\text{ m}\Omega$ to $+1\ \Omega$.

Front Panel:	SCPI Command:
Select Output\Advanced\Resistance. Enter a value and press Select.	To set the output resistance to $0.5\ \Omega$: OUTP:RES 0.5, (@1)

Set the Output Bandwidth

NOTE

This information applies to Agilent Models N678xA SMU only.

Agilent Models N678xA SMU have several voltage bandwidth modes to allow you to optimize output response time with capacitive loads.

The Low bandwidth setting provides stability with a wide range of output capacitors. Additional bandwidth modes provide faster output response when the output capacitance is restricted to smaller values.

If capacitive loads cause the output to oscillate on the default (Low bandwidth) or any of the other bandwidth settings, a protection function will detect the oscillation and latch the output off. The condition is annunciated by the OSC status bit. At power-on the oscillation protection function is enabled.

Select a bandwidth according to the following output capacitances and lead lengths:

Setting	Output Capacitance	Sensing	Maximum distance from sense point to capacitor	ESR @100 kHz
Low	0–150 μ F	Local or remote	Full lead length (see chapter 2)	50 to 200 m Ω
High1	0–1 μ F	Remote only	6 inches (155 mm)	50 to 200 m Ω
High2	1–7 μ F	Remote only	6 inches (155 mm)	50 to 200 m Ω
High3	7–150 μ F	Remote only	6 inches (155 mm)	50 to 200 m Ω

See Chapter 2 under “Agilent N678xA SMU Wiring Requirements” for additional information on allowable load lead lengths.

NOTE

Connecting capacitive loads that fall outside the indicated ranges may result in output instability or oscillation, and may cause the output to turn off, setting the OSC status bit.

Front Panel:	SCPI Command:
Select Output\Advanced\Bandwidth. Select a bandwidth from the selections listed and press Select.	To select the bandwidth: VOLT:BWID HIGH1 , (@1)

Set the Output Turn-Off Mode

NOTE

This information applies to Agilent Models N678xA SMU only.

This lets you specify high impedance or low impedance mode at output turn-on and turn-off.

Low impedance - At turn-on the output relays are closed after which the output is programmed to the set value. At turn-off the output is first programmed to zero, after which the output relays are opened.

High impedance – At turn-on the output is programmed to the set value after which the output relays are closed. At turn-off the output relays are opened while the output remains at its set value. This reduces current pulses that may be undesirable in some applications.

Front Panel:	SCPI Command:
Select Output\Advanced\Tmode. Select either High Impedance or Low impedance and press Select.	To set output 1 to a high impedance mode: OUTP:TMOD HIGHZ , (@1)

Synchronizing Output Steps

The transient system lets you step the output voltage and current up or down in response to triggered events. To generate a triggered output step you must:

1. Enable the output to respond to trigger commands.
2. Set the voltage or current trigger levels.
3. Select the transient trigger source.
4. Initiate the trigger system and provide a trigger signal.

Enable the Output to Respond to Trigger Commands

First, you must enable the output to respond to trigger commands. Unless an output is enabled to respond to triggers, nothing will happen even if you have programmed a trigger level and generated a trigger for the output.

Use the following commands to enable an output to respond to triggers:

Front Panel:	SCPI Command:
Select Transient\Mode . For voltage step triggering, set the Voltage mode to Step. For current step triggering, set the Current mode to Step. Then press Select.	To enable the voltage function on output 1 to respond to triggers, use: <code>VOLT:MODE STEP, (@1)</code> To enable the current function on output 1 to respond to triggers, use: <code>CURR:MODE STEP, (@1)</code>

NOTE

In Step mode, the triggered value becomes the immediate value when the trigger is received. In Fixed mode, trigger signals are ignored; the immediate values remain in effect when a trigger is received.

Set the Voltage or Current Trigger Levels

Next, use the following commands to program an output trigger level. The output will go to this level when the trigger is received.

If you have a model that has multiple ranges, the selected triggered voltage and current settings must be within the **same** range that the output channel is presently operating in.

Front Panel:	SCPI Command:
Select Transient\Step . Select the Trig Voltage box to set the voltage. Select the Trig Current box to set the current. Enter a value and press Select.	To set a voltage and current trigger level for output 1 use: <code>VOLT:TRIG 15, (@1)</code> <code>CURR:TRIG 1, (@1)</code>

Select the Transient Trigger Source

NOTE

An immediate trigger command either from the front panel or over the bus will generate an immediate trigger regardless of the trigger source.

Unless you are using the front panel menu or a TRIGger:TRANsient command to trigger the output, select a trigger source from the following:

- Bus** Selects GPIB device trigger, *TRG, or <GET> (Group Execute Trigger).
- Pin<n>** Selects a pin on the external port connector as the trigger source. <n> specifies the pin number. The selected pin must be configured as a Trigger Input in order to be used as a trigger source (see Appendix B).
- Transient<n>** Selects the output channel’s transient system as the trigger source. <n> specifies the channel. When you select a channel, you must also set up that channel’s transient system to generate a trigger out signal. Refer to “Generate Trigger Out Signals”.
- Ext** Selects any pin configured as a trigger input as the trigger source.

Use the following commands to select a trigger source:

Front Panel:	SCPI Command:
To select Bus triggers, select Transient\TrigSource . Select Bus.	To select Bus triggers for output 1: TRIG:TRAN:SOUR BUS, (@1)
To select Digital pin triggers, select Transient\TrigSource . Then select one of the digital port pins.	To select Digital pin triggers: TRIG:TRAN:SOUR PIN<n>, (@1) where n is the pin number.
To select Transient output triggers, select Transient\TrigSource . Then select one of the output channels.	To select Transient output triggers: TRIG:TRAN:SOUR TRAN<n>, (@1) where n is the output channel that will generate the trigger signal.

Initiate the Transient Trigger System

Next, you must initiate or enable the transient trigger system.

When the power system is turned on, the trigger system is in the idle state. In this state, the trigger system is disabled, ignoring all triggers. Initiating the trigger system moves it from the idle state to the initiated state, which enables the power system to receive triggers. To initiate the trigger system, use:

Front Panel:	SCPI Command:
Select the Transient\Control . Scroll to Initiate and press Select.	To initiate the transient trigger system: INIT:TRAN (@1)

It takes a few milliseconds for the instrument to be ready to receive a trigger signal after receiving the INITiate:TRANsient command.

If a trigger occurs before the trigger system is ready for it, the trigger will be ignored. You can test the WTG_tran bit in the operation status register to know when the instrument is ready to receive a trigger after being initiated.

Front Panel:	SCPI Command:
Not Available	To query the WTG_tran bit (bit 4): STAT:OPER:COND? (@1)

If a bit value of 16 is returned in the query, the WTG_tran bit is true, and the instrument is ready to receive the trigger signal. Refer to the N6700 Programmer’s Reference Help file for more information.

NOTE Unless INITiate:TRANsient;CONTInuous is programmed, it will be necessary to initiate the transient trigger system each time a triggered action is desired.

Trigger the Output

The trigger system is waiting for a trigger signal in the initiated state. You can immediately trigger the output as follows:

Front Panel:	SCPI Command:
Select Transient\Control . Select Trigger to generate an immediate trigger signal regardless of the trigger source setting.	To generate an immediate trigger on channel 1: TRIG:TRAN (@1) Alternatively, if the trigger source is BUS, you can also program a *TRG or an IEEE-488 <get> command

As previously discussed, a trigger can also be generated by another output channel or by a trigger signal applied to an input pin on the digital port connector. If any of these systems are configured as the trigger source, the instrument will wait indefinitely for the trigger signal. If the trigger does not occur, you must manually return the trigger system to the idle state.

The following commands return the trigger system to the idle state:

Front Panel:	SCPI Command:
Select Transient\Control . Scroll to and select Abort.	ABOR:TRAN (@1)

When a trigger is received, the triggered functions are set to their programmed trigger levels. When the triggered actions are completed, the trigger system returns to the idle state.

You can test the TRAN_active bit in the operation status register to know when the transient trigger system has returned to the idle state.

Front Panel:	SCPI Command:
Not Available	To query the TRAN_active bit (bit 6): STAT:OPER:COND? (@1)

If a bit value of 64 is returned in the query, the TRAN_active bit is true, and the transient action is NOT complete. When the TRAN_active bit is false, the transient action is complete. Refer to the N6700 Programmer's Reference Help file for more information.

Generate Trigger Out Signals

Each output channel can generate trigger signals that can be used by other output channels, or routed to a pin on the digital port that has been configured as a trigger output (TOUT). Use the following commands to program transient trigger signals that are generated when an output Step occurs:

Front Panel:	SCPI Command:
Use the Channel key to select the channel that is the trigger source. Select Transient\Step . Check Enable Trigger Output. Then press Select.	To program channel 3's step function to generate a trigger signal, use STEP:TOUT ON, (@3)

Programming Output Lists

NOTE

The Output List function described in this section is not available on all models. Refer to the Test Extensions feature under “Model Differences” in chapter 1,

The List Function

Either output voltage or output current or both, may be list-controlled. For Agilent Models N678xA SMU, only the parameters associated with *one* of the priority modes (either voltage priority or current priority) may be list controlled. List mode lets you generate complex sequences of output changes with rapid, precise timing, which may be synchronized with internal or external signals. Lists can contain up to 512 individually programmed steps, and can be programmed to repeat themselves.

The voltage and current lists are paced by a separate list that defines the duration or dwell of each step. Each of the up to 512 steps can have an individual dwell time associated with it, which specifies the time in seconds that the list will remain at that step before moving on to the next step. Dwell times can be programmed from 0 to 262.144 seconds. The default dwell time is 0.001 seconds.

If you need an output list to closely follow external events, then a trigger-paced list is more appropriate. In a trigger-paced list, the list advances one step for each trigger received. As previously discussed, a number of trigger sources can be selected to generate triggers. With a trigger-paced list, you do not need to program a dwell time for each step. If you do program a dwell time, triggers that are received during the dwell period are ignored.

Voltage and current lists can also be configured to generate trigger signals at specified steps. This is accomplished by two additional lists: a beginning-of-step (BOST) and an end-of-step (EOST) list. These lists define which steps will generate a trigger signal and if the trigger occurs at the beginning or end of the step. These trigger signals can be used to synchronize other events with the list.

When either a voltage or current list is programmed, the associated dwell, BOST, and EOST lists must all be set to the same number of steps, otherwise an error will occur when the list is run. For convenience, a list may be programmed with only one step or value. In this case, a single-step list is treated as if it had the same number of steps as the other lists, with all values being equal to the one value.

NOTE

List data is not stored in non-volatile memory. This means that list data that is sent to the instrument either from the front panel or over the bus will be lost when the power system is turned off. However, list data can be saved as part of a saved instrument state. Refer to “Instrument State Storage” later in this chapter.

Program an Output Pulse or Pulse Train

The following procedure shows how to generate an output pulse train using the List function.

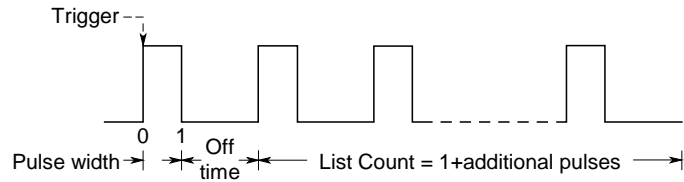

- Step 1.** Set the voltage or current function for which you want to generate a pulse to List mode. This example programs a voltage pulse.

Front Panel:	SCPI Command:
Select Transient\Mode . Set the voltage mode to List. Press Select.	To program output 1, use VOLT:MODE LIST, (@1)

- Step 2.** Set the amplitude and width of the pulse. For example, to generate a pulse with an amplitude of 15 V and a pulse width of 1 second, use:

Front Panel:	SCPI Command:
Select Transient>List\Config .	To program output 1, use
Select List Step 0 and enter a voltage value of 15. Press Select.	LIST:VOLT 15, (@1)
Enter a dwell value of 1 for List Step 0 and Press Select.	LIST:DWEL 1, (@1)

- Step 3.** Set the list pacing to Auto, so that as each dwell time elapses, the next step is immediately output.

Front Panel:	SCPI Command:
Select Transient>List\Pace .	LIST:STEP AUTO, (@1)
Select Dwell and press Select.	

If you only wish to program a single pulse, skip steps 4 and 5 and go to step 6.

- Step 4.** If you want to generate a pulse train, you must specify the off time between pulses. To do this you must program another step. For a voltage list, you must specify an amplitude and an off time. For example, to program an off time of 2 seconds with an amplitude of 0 V between pulses, use:

Front Panel:	SCPI Command:
Select Transient>List\Config .	To program output 1, use
Select List Step 1 and enter a voltage value of 0. Press Select.	LIST:VOLT 15,0, (@1)
Enter a dwell value of 2 for List Step 1 and Press Select.	LIST:DWEL 1,2, (@1)

Step 5. To generate a pulse train, you can simply repeat the pulse as needed. For example, to program a pulse train of 50 pulses, use:

Front Panel:	SCPI Command:
Select Transient\List\Repeat . Enter the number of list repetitions (50) and Press Select.	To program output 1, use LIST:COUN 50, (@1)

Step 6. Specify if you want the output pulse to generate a trigger signal that can be used to trigger actions on other output channels or on any external equipment connected to the digital port. For example, to generate a trigger signal at the end of the pulse, use:

Front Panel:	SCPI Command:
Select Transient\List\Config . Select List Step 0 and check the Tout Step box. Press Select.	To program a trigger at the End of the pulse for output 1, use LIST:TOUT:EOST 1,0, (@1) You must program a value of 0 (no trigger) for step 1 as a placeholder.

Step 7. Specify the output state after the pulse has completed. For example, to return the output to the state it was in before the pulse, use:

Front Panel:	SCPI Command:
Select Transient\List\Terminate . Select Return to Start. Press Select.	To program output 1, use LIST:TERM:LAST 0, (@1)

Step 8. Select the trigger source that will generate the pulse or pulse train. For example, to select Bus triggers as the trigger source, use:

Front Panel:	SCPI Command:
Select Transient\TrigSource . Select Bus and press Select.	To program output 1, use: TRIG:TRAN:SOUR BUS, (@1)

Step 9. Initiate the transient trigger system. To enable the trigger system for one transient event or trigger use:

Front Panel:	SCPI Command:
Select the Transient\Control . Select Initiate and Press Select.	To program output 1, use INIT:TRAN (@1)

Step 10. Trigger the output pulse or pulse train.

Front Panel:	SCPI Command:
Select Transient\Control . Select Trigger and Press Select.	*TRG

Program an Arbitrary List

The following procedure shows how to generate the list of voltage changes as illustrated in the following figure.

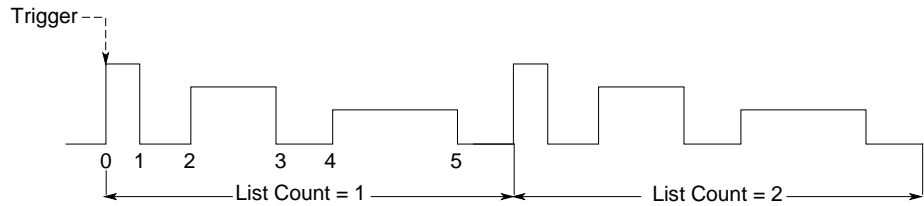

Step 1. Set the function, voltage or current, for which you want to generate a list to List mode. This example programs a voltage list.

Front Panel:	SCPI Command:
Select Transient\Mode . Set the Voltage mode to List. Press Select.	To program output 1, use VOLT:MODE LIST, (@1)

Step 2. Program the list of values for the List function. The order in which the values are entered determines the order in which the values will be output. To generate the voltage list shown in the figure, a list may include the following values: 9, 0, 6, 0, 3, 0

Front Panel:	SCPI Command:
Select Transient>List\Config . Select the List Step number and enter a voltage value. Press Select. Repeat this for each step. Use the ↑ ↓ keys to select the next step.	To program output 1, use LIST:VOLT 9,0,6,0,3,0, (@1)

Step 3. Determine the time interval, in seconds, that the output remains at each step in the list before it advances to the next step. To specify the six dwell intervals in the figure, a list may include the following values: 2, 3, 5, 3, 7, 3

Front Panel:	SCPI Command:
Select Transient>List\Config . Select the List Step number and enter a dwell value. Press Select. Repeat this for each step. Use the ↑ ↓ keys to select the next step.	To program output 1, use LIST:DWEL 2,3,5,3,7,3, (@1)

NOTE

The number of dwell steps must equal the number of voltage steps. If a dwell list has only one value, that value will be applied to all steps in the list.

Step 4. Determine how the list is paced. To pace the list by dwell time, set the list pacing to Dwell-paced on the front panel menu. (Set the LIST:STEP command to AUTO.) As each dwell time elapses, the next step is immediately output.

Front Panel:	SCPI Command:
Select Transient\List\Pace . Select Dwell-paced. Press Select.	LIST:STEP AUTO, (@1)

In a trigger-paced list, the list advances one step for each trigger received. To enable trigger-paced lists, select Trigger-paced on the front panel menu. (Set the LIST:STEP command to ONCE.)

The dwell time associated with each step determines the minimum time that the output remains at the step. If a trigger is received before the dwell time completes, the trigger is ignored. To ensure that no triggers are lost in a trigger-paced list, set the dwell time to zero.

Step 5. Specify if you want the list to generate trigger signals that can be used to trigger actions on other output channels or on external equipment connected to the digital port.

Front Panel:	SCPI Command:
Select Transient\List\Config . Select the List Step number. To generate a trigger, enter a 1 in the Tout Begin Step or Tout End Step field. If a zero is entered, no trigger is generated for the step. Repeat this for each step. Use the ↑ ↓ keys to select the next step.	To program a trigger at the beginning of step 4 for output 1, use LIST:TOUT:BOST 0,0,0,0,1,0, @1) To program a trigger at the end of step 0, 2, and 4 for output 1, use LIST:TOUT:EOST 1,0,1,0,1,0, @1)

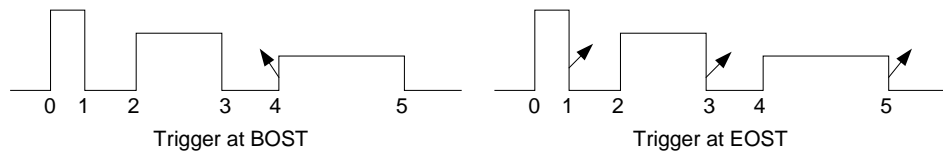

Step 6. Specify how you want the list to terminate. For example, if you want the list to remain at the values of the last list step when finished, use:

Front Panel:	SCPI Command:
Select Transient\List\Terminate . Select Stop Last Step. Press Select.	To program output 1, use LIST:TERM:LAST 1, (@1)

Step 7. If applicable, specify how many times you want the list to repeat. Sending the INFinity parameter in the SCPI command makes the list repeat indefinitely. At reset, the list count is set to 1.

Front Panel:	SCPI Command:
Select the Transient\List\Repeat . Enter the number of list repetitions (2) and Press Select.	To program the output 1 list to repeat 2 times, use LIST:COUN 2, (@1)

Step 8. Select a trigger source, initiate, and trigger the list. This is described in detail under "Synchronizing Output Steps".

Making Measurements

Each output channel has its own measurement capability. The output voltage and current is measured by acquiring a number of samples at the selected time interval, applying a window function to the samples, and *averaging* the samples.

The power-on time interval is 20.48 microseconds. The output window function is Rectangular.

Use the following commands to make a simple measurement:

Front Panel:	SCPI Command:
Select the Meter key.	To measure average voltage or current: MEAS : VOLT? (@1) MEAS : CURR? (@1)

Measurement Ranges

Some models have multiple voltage and current measurement ranges. (Refer to Chapter 1, “Model Differences”). Selecting a lower measurement range provides greater measurement accuracy, provided the measurement does not exceed the range.

Front Panel:	SCPI Command:
Select Measure\Range .	To set the 5 V measurement range: SENS : VOLT : RANG 5 , (@1)
Select the lower measurement range from the voltage or current dropdown menu. Then press Select.	To set the 1 A measurement range: SENS : CURR : RANG 1 , (@1)

The maximum measurable current is the maximum rating of the range. If the measurement exceeds the range, an “Overload” error will occur. Examples of programming measurement ranges are:

3.06 A range	To select, program values > 0.1 A and ≤ 3.06 A.
0.10 A range	To select, program values > 200 μA and ≤ 0.1 A.
200 μA range (option 2UA)	To select, program values ≤ 200 μA.

Seamless Measurements

Seamless voltage and current measurement autoranging is available on Agilent Models N6781A and N6782A. This enables a wide dynamic measurement range with no data lost across ranges. Autoranging does not include the 10 μA range, which must be selected manually.

Front Panel:	SCPI Command:
Not Available	To enable seamless voltage or current autoranging on channel 1: SENS : VOLT : RANG : AUTO ON , (@1) SENS : CURR : RANG : AUTO ON , (@1)

Simultaneous Voltage and Current Measurements

Some models have simultaneous voltage and current measurement capability (Refer to Chapter 1, “Model Differences”). In this case BOTH voltage and current can be acquired on any measurement.

Front Panel:	SCPI Command:
Not available.	Select the measurement function: SENS:FUNC:VOLT ON, (@1) SENS:FUNC:CURR ON, (@1) Initiate and trigger the measurement system: INIT:ACQ (@1) TRIG:ACQ (@1) Fetch the voltage and current measurement: FETC:VOLT? (@1) FETC:CURR? (@1)

Agilent N6781A Auxiliary Voltage Measurements

The Agilent N6781A has an auxiliary voltage measurement input, whose primary use is for battery voltage rundown measurements. It may also be suitable for other applications including general purpose DC voltage measurements between +/-20 VDC. The auxiliary voltage measurement input is isolated from other commons. It has a bandwidth of about 2 kHz. It has one input range: -20 to +20 VDC.

Auxiliary voltage measurements cannot be made along with output voltage measurements. When the auxiliary voltage measurement input is selected, the voltage measurement input will be switched to the Aux Voltage inputs on the Agilent N6781A instead of the normal + and - sense terminals.

To enable auxiliary voltage measurements:

Front Panel:	SCPI Command:
Select Measure\Input .	To enable auxiliary measurements:
Select Auxiliary and press Select.	SENS:FUNC:VOLT:INP AUX, (@1)
Select Main to reconnect the voltage measurement input to the output terminals.	Take the auxiliary voltage measurement: MEAS:VOLT? (@1)

NOTE

When the auxiliary voltage measurement terminals are left unconnected, the front panel meter will indicate a voltage reading of approximately 1.6V. This is a normal indication which does not affect the voltage measurement once the auxiliary measurement terminals are connected.

Using the Digitizer

NOTE

The Digitizer functions described in this section are not available on all models. Refer to the Test Extensions feature under “Model Differences” in chapter 1.

The digitizer function lets you access the enhanced voltage and current measurement capabilities of the power system. You can:

- Specify a measurement function and range.
- Adjust the measurement sample rate.
- Select a measurement window that can attenuate AC noise.
- Retrieve arrays of the digitized current or voltage measurement.
- Synchronize measurements using trigger signals.

NOTE

When a remote interface measurement is in progress, the front panel display may indicate “-- -- -- --”. Front panel measurements resume when the remote measurement completes.

Programming the Digitizer

Select the Measurement Function and Range

The following commands select a measurement function. To enable the measurement function, use:

Front Panel:	SCPI Command:
Not Available	To enable voltage measurements: SENS:FUNC:VOLT ON, (@1)
	To enable current measurements: SENS:FUNC:CURR ON, (@2)

If a power module has simultaneous measurements (see chapter 1, “Model Differences”), you can enable BOTH voltage and current measurements on the same output channel.

Some power modules also have multiple measurement ranges. Selecting a lower measurement range provides greater measurement accuracy, provided that the measurement does not exceed the range. To select lower measurement ranges, use:

Front Panel:	SCPI Command:
Select Measure\Range .	To set the 5 V measurement range: SENS:VOLT:RANG 5, (@1)
Select the lower measurement range from the voltage or current dropdown menu. Then press Select.	To set the 1 A measurement range: SENS:CURR:RANG 1, (@1)

Seamless Measurements

Seamless voltage and current measurement autoranging is available on Agilent Models N6781A and N6782A. This enables a wide dynamic measurement range with no data lost across ranges. Autoranging does not include the 10 μ A range, which must be selected manually.

Front Panel:	SCPI Command:
Not Available	To enable seamless voltage or current autoranging on channel 1: <code>SENS:VOLT:RANG:AUTO ON, (@1)</code> <code>SENS:CURR:RANG:AUTO ON, (@1)</code>

Adjust the Measurement Sample Rate

The following figure illustrates the relationship between measurement samples (or points), and the time interval between samples in a typical measurement.

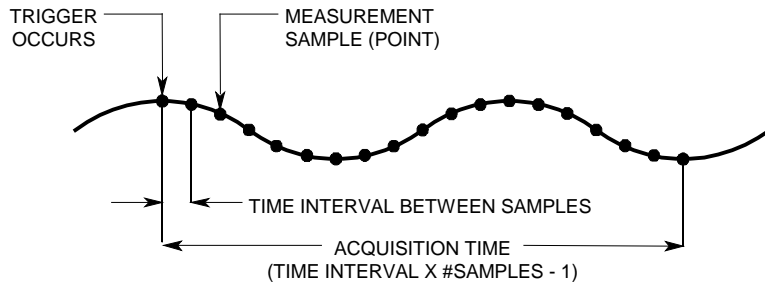

You can vary the measurement data sampling rate as follows:

Front Panel:	SCPI Command:
Select Measure\Sweep . Enter the number of points and press Select. Scroll to Time Interval, enter a value and press Select.	To set the time interval to 60 μ s* with 4096 samples, use: <code>SENS:SWE:TINT 60E-6, (@1)</code> <code>SENS:SWE:POIN 4096, (@1)</code>

The maximum number of sample points that are available for all measurements is 512 K points (K = 1024). If you specify a voltage measurement with 500 K points on channel 1 for example, you will only have 12 K points available for all other measurements.

Time interval values can range from 5.12 microseconds (for one parameter on Models N678xA SMU) to 40,000 seconds. Note that the shortest time interval (fastest speed) that can be specified depends on the number of parameters that are being measured, the model that is doing the measuring, and the time interval resolution.

- 5.12 microseconds:** 1 parameter (models N678xA SMU only)
- 10.24 microseconds:** 1 or 2 parameters (all models)
- 20.48 microseconds:** 3 or 4 parameters (all models, with 20 μ s resolution)
- 20.48 microseconds:** Up to 8 parameters (all models, with 40 μ s resolution)

Time interval values from 10.24 up to 20.48 microseconds are rounded to the nearest 10.24-microsecond increment. Values above 20.48 microseconds are rounded to the nearest 20.48-microsecond increment when the resolution is set to RES20. Values above 20.48 microseconds are rounded to the nearest 40.96-microsecond increment when the resolution is set to RES40.

You can change the time interval resolution as follows:

Front Panel:	SCPI Command:
Not Available	To set the resolution to 20 microseconds: SENS:SWE:TINT:RES RES20, (@1) To set the resolution to 40 microseconds: SENS:SWE:TINT:RES RES40, (@1)

Specify a Window Function

Windowing is a signal conditioning process that reduces the error in average measurements made in the presence of periodic signals and noise. Two window functions are available: Rectangular and Hanning. At power-on, the measurement window is Rectangular.

The Rectangular window calculates average measurements without any signal conditioning. However, in the presence of periodic signals such as AC line ripple, a Rectangular window can introduce errors when calculating average measurements. This can occur when a non-integral number of cycles of data has been acquired due to the last partial cycle of acquired data.

One way of dealing with AC line ripple is to use a Hanning window. The Hanning window applies a \cos^4 weighting function to the data when calculating average measurements. This attenuates the AC noise in the measurement window. The best attenuation is achieved when at least three or more waveform cycles are in the measurement.

Front Panel:	SCPI Command:
Select Measure\Window . Then select either Rectangular or Hanning and press Select.	To set the sense window to Hanning for output 1 use: SENS:WIND HANN, (@1)

Send the Measurement Command

The following commands trigger and return measurement data.:

Front Panel:	SCPI Command:
Select the Meter key. Front panel meters can only measure average voltage and current.	To measure average voltage & current: MEAS:VOLT? (@1) MEAS:CURR? (@1) To measure RMS voltage & current: MEAS:VOLT:ACDC? (@1) MEAS:CURR:ACDC? (@1)

Front Panel:	SCPI Command:
Not Available	<p>To measure the high level of a pulse: MEAS : VOLT : HIGH? (@1) MEAS : CURR : HIGH? (@1)</p> <p>To measure the low level of a pulse: MEAS : VOLT : LOW? (@1) MEAS : CURR : LOW? (@1)</p> <p>To measure the maximum value: MEAS : VOLT : MAX? (@1) MEAS : CURR : MAX? (@1)</p> <p>To measure the minimum value: MEAS : VOLT : MIN? (@1) MEAS : CURR : MIN? (@1)</p> <p>To measure power: MEAS : POW? (@1)</p>

Power can only be measured on power modules with simultaneous measurement capability (see chapter 1, “Model Differences”)

Array queries return all values in the voltage and current measurement buffer. No averaging is applied, only raw data is returned from the buffer.

Front Panel:	SCPI Command:
Not Available	MEAS : ARR : VOLT? (@1) MEAS : ARR : POW? (@1) MEAS : ARR : CURR? (@1)

Retrieve array data

Once a measurement finishes, you may wish to retrieve the array data without initiating a new measurement. Use FETCh queries to return the array data from the last measurement. Fetch queries do not alter the data in the measurement buffer. The commands are:

Front Panel:	SCPI Command:
Not Available	FETC : ARR : VOLT? (@1) FETC : ARR : POW? (@1) FETC : ARR : CURR? (@1)

Power can only be measured on power modules with simultaneous measurement capability (see chapter 1, “Model Differences”)

If a FETCh query is sent before the measurement is started or before it is finished, the response will be delayed until the measurement trigger occurs and the acquisition completes. This may tie up the computer if the measurement trigger does not occur immediately. You can test the MEAS_active bit in the operation status register to know when the measurement has completed as explained in the following section.

Synchronizing Digitizer Measurements

Use the measurement trigger system to synchronize the acquisition of measurements with a Bus, Transient, or an external trigger. Then use FETCh commands to return voltage or current information from the acquired data. Briefly, to make a triggered measurement:

- Select the measurement function to trigger.
- Adjust the measurement to capture pre-trigger data.
- Select the trigger source.
- Initiate the trigger system and generate a trigger.
- Fetch the triggered measurements.

Select the Measurement Function to Trigger

The following commands select a measurement function.

Front Panel:	SCPI Command:
Not Available	To select the voltage measurement function: SENS:FUNC:VOLT ON, (@1)
	To select the current measurement function: SENS:FUNC:CURR ON, (@1)

Some power modules have two measurement converters, which allow simultaneous voltage and current measurements (Refer to Chapter 1, “Model Differences”). In that case, BOTH voltage and current measurements can be enabled. If a power module has only one converter, the parameter that it measures (either voltage or current) must be specified.

Capture Pre-trigger Data

The measurement system lets you capture data before, after, or at the trigger signal. As shown in the following figure, you can move the block of data being read into the acquisition buffer with reference to the trigger. This allows pre- or post-trigger data sampling.

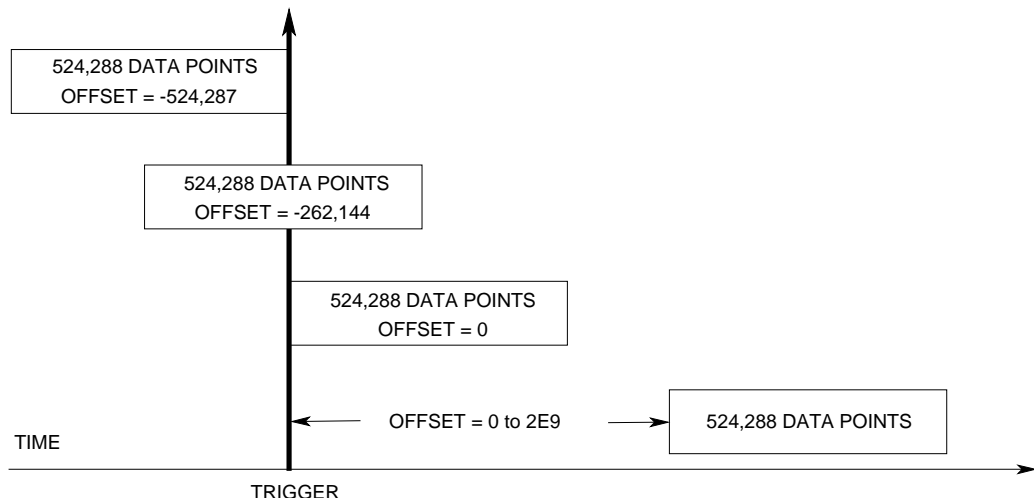

To offset the beginning of the acquisition buffer relative to the acquisition trigger, use:

Front Panel:	SCPI Command:
Select Measure\Sweep . Enter an offset value and press Select.	To offset the measurement on channel 1 by 100 points use: SENS:SWE:OFFS:POIN 100, (@1)

When the value is 0, all values are taken after the trigger. Values greater than 0 can be used to program a delay time from the receipt of the trigger until the values entered into the buffer are valid. (Delay time = offset x sample period). Negative values let you acquire samples prior to the trigger.

NOTE If, during a pre-trigger data acquisition, a trigger occurs before the pre-trigger data count is completed, the measurement system ignores this trigger. This will prevent the completion of the measurement if another trigger is not generated.

Select the Measurement Trigger Source

NOTE An immediate trigger command over the bus will generate an immediate trigger regardless of the trigger source.

Unless you are using a TRIGGER:ACQUIRE command to trigger the measurement, select a trigger source from the following:

- Bus** Selects GPIB device trigger, *TRG, or <GET> (Group Execute Trigger).
- External** Selects any pin configured as a trigger input as the trigger source.
- Pin<n>** Selects a pin on the external port connector as the trigger source. <n> specifies the pin number. The selected pin must be configured as a Trigger Input in order to be used as a trigger source (see Appendix B).
- Transient<n>** Selects the output channel’s transient system as the trigger source. <n> specifies the channel. When you select a channel, you must also set up that channel’s transient system to generate a trigger out signal. See “Generate Trigger Out Signals” and “Program an Arbitrary List” earlier in this chapter.

Use the following commands to select a trigger source:

Front Panel:	SCPI Command:
Not Available	To select Bus triggers for output 1: TRIG:ACQ:SOUR BUS, (@1) To select a Digital pin as the trigger: TRIG:ACQ:SOUR PIN<n>, (@1) To select a Transient output as trigger: TRIG:ACQ:SOUR TRAN<n>, (@1) where n is the output channel that will generate the trigger signal.

Initiate the Measurement Trigger System

Next, you must initiate or enable the measurement trigger system.

When the power system is turned on, the trigger system is in the idle state. In this state, the trigger system is disabled, ignoring all triggers. The INITiate commands enable the trigger system to receive triggers. To initiate the trigger system, use:

Front Panel:	SCPI Command:
Not Available	To initiate the measurement trigger system: INIT:ACQ (@1)

It takes a few milliseconds for the instrument to be ready to receive a trigger signal after receiving the INITiate:ACQUIRE command, and it can take longer for Agilent Models N678xA SMU.

If a trigger occurs before the trigger system is ready for it, the trigger will be ignored. You can test the WTG_meas bit in the operation status register to know when the instrument is ready to receive a trigger after being initiated.

Front Panel:	SCPI Command:
Not Available	To query the WTG_meas bit (bit 3): STAT:OPER:COND? (@1)

If a bit value of 8 is returned in the query, the WTG_meas bit is true, and the instrument is ready to receive the trigger signal. Refer to the N6700 Programmer's Reference Help file for more information.

NOTE

It will be necessary to initiate the measurement trigger system each time a triggered measurement is desired.

Trigger the Measurement

The trigger system is waiting for a trigger signal in the initiated state. You can immediately trigger the measurement as follows:

Front Panel:	SCPI Command:
Not Available	To generate a measurement trigger: TRIG:ACQ (@1) Alternatively, if the trigger source is BUS, you can also program a *TRG or an IEEE-488 <get> command.

As previously discussed, a trigger can also be generated by another output channel or an input pin on the digital port connector. If any of these systems are configured as the trigger source, the instrument will wait indefinitely for the trigger signal. If the trigger does not occur, you must manually return the trigger system to the idle state.

The following commands return the trigger system to the idle state:

Front Panel:	SCPI Command:
Select Measure\Control . Then select the Abort control.	ABOR:ACQ (@1)

Fetch the Measurement

After a trigger is received and the data acquisition completes, the trigger system will return to the idle state. When this occurs, you can use FETCh queries to return the measurement data.

Front Panel:	SCPI Command:
Not Available	To return average voltage & current: FETC:VOLT? (@1) FETC:CURR? (@1) To return RMS voltage & current: FETC:VOLT:ACDC? (@1) FETC:CURR:ACDC? (@1) To return the high level of a pulse: FETC:VOLT:HIGH? (@1) FETC:CURR:HIGH? (@1) To return the low level of a pulse: FETC:VOLT:LOW? (@1) FETC:CURR:LOW? (@1) To return the maximum value: FETC:VOLT:MAX? (@1) FETC:CURR:MAX? (@1) To return the minimum value: FETC:VOLT:MIN? (@1) FETC:CURR:MIN? (@1) To return power: FETC:POW? (@1)

Power can only be measured on power modules with simultaneous measurement capability (see chapter 1, “Model Differences”)

If a FETCh query is sent before the measurement is finished, the response will be delayed until the measurement trigger occurs and the acquisition completes. You can test the MEAS_active bit in the operation status register to know when the measurement trigger system has returned to the idle state.

Front Panel:	SCPI Command:
Not Available	To query the MEAS_active bit (bit 5): STAT:OPER:COND? (@1)

If a bit value of 32 is returned in the query, the MEAS_active bit is true, and the measurement is NOT complete. When the MEAS_active bit is false, you can retrieve the measurement. Refer to the N6700 Programmer’s Reference Help file for more information.

Using the Protection Functions

Each output has independent protection functions. A front panel status indicator will turn on when a protection function has been set. Protection functions are latching, which means that they must be cleared once they have been set. As explained under “Couple Output Protection” you can configure the instrument so that when a protection fault occurs on one output, ALL outputs will be turned off.

Of the following protection functions, only OV, OV-, OC, OSC, PROT, and INH are user- programmable.

OV	Over-voltage protection is a hardware OVP whose trip level is a programmable value. The OVP is always enabled.
OV-	Negative voltage protection is a hardware OVP. Only applies to Agilent N678xA SMU and N6783A.
OC	Over-current protection is a programmable function that can be enabled or disabled. When enabled, the output will be disabled when the output current reaches the current limit setting.
OT	Over-temperature protection monitors the temperature of each output and shuts down the output if any temperature exceeds the maximum factory-defined limits.
OSC	Oscillation protection shuts down the output if an oscillation is detected on the output. Only applies to Agilent N678xA SMU.
PF	PF indicates that a power fail condition on the AC mains has disabled the output.
CP+	CP+ indicates that a positive power limit condition has disabled the output. This protection function does not apply to all power modules. Refer to Appendix C for further information.
CP-	CP- indicates that a negative power limit condition has disabled the output. This protection function does not apply to all power modules. Refer to Appendix C for further information.
PROT	Prot indicates that the output is disabled, either because of a coupled protection signal from another output, or because the programmed output watchdog time has expired.
INH	The Inhibit input (pin 3) on the rear panel digital connector can be programmed to act as an external shutdown signal. Refer to Appendix B for further information.

Set the Over-Voltage Protection

The over-voltage protection function turns off the affected output if the output voltage reaches the programmed over-voltage limit. The OVP circuit monitors the voltage at the + and – output terminals. However, on Agilent Models N678xA SMU and units with Option J01, the voltage is monitored at the + and – sense terminals. This allows for more precise over-voltage monitoring directly at the load.

Units with **Option J01** have tracking OVP in addition to the standard overvoltage protection. It lets you set an overvoltage protection limit that is offset from the programmed voltage. The tracking OVP threshold automatically tracks the real time programmed settings. Option J01 is only available on models N6752A, N6754A and N6762A.

Front Panel:	SCPI Command:
Select Protect\OVP . Enter a value in the OVP level box and press Select. For J01 units, enter a value in the Tracking OVP Offset box and check the Enable box. Then press Select.	To set an OVP of 10 V for output 1: VOLT:PROT 10, (@1, 2) For Models N678xA SMU: VOLT:PROT:REM 10, (@1, 2) To enable tracking OVP for output 1: VOLT:PROT:TRAC ON, (@1) To set the tracking offset for output 1: VOLT:PROT:TRAC:OFFS 2, (@1)

Agilent Models N678xA SMU also have a back-up local OVP function. Refer to “Over-voltage Protection” in chapter 2 for a description of the feature. Additionally, for Agilent Model N6784A, you can program a negative over-voltage value. Enter the value in the -OVP field.

Set the Over-Current Protection

When over-current protection is enabled, the power system turns off the output if the output current reaches the current limit setting and transitions from CV to CC mode.

Front Panel:	SCPI Command:
Select Protect\OCP . Check Enable OCP and press Select.	To enable OCP for outputs 1 and 2: CURR:PROT:STAT 1, (@1, 2)

You can also specify an OCP delay to prevent momentary CV-to-CC status changes from tripping the over-current protection. The power system may momentarily transition into CC mode when it is turned on, when an output value is programmed, or when the output load is connected. In most cases these temporary conditions would not be considered an over-current protection fault, and having an OCP condition disable the output when the CC status bit is set would be a nuisance. Specifying an OCP delay lets the OCP circuit ignore the CC status bit during the specified delay period. Once the OCP delay time has expired and if the CC mode persists, the output will shut down.

The delay can be programmed from 0 to 0.255 seconds. You can specify if the OCP delay timer is started by *any* transition of the output into CC mode, or only at the end of a *settings* change in voltage, current, or output state.

Front Panel:	SCPI Command:
Select Protect\OCP . Enter a delay value and press Select.	To specify a 10 millisecond delay: OUTP:PROT:DEL 0.01, (@1)
Check "Start delay on CC" to start the delay timer by ANY output transition into CC mode. Otherwise, the delay timer will only be started by a settings change in voltage, current, or output state.	To start the delay timer by ANY output transition into CC mode: CURR:PROT:DEL:STAR CCTR, (@1) To start the delay timer by a settings change in voltage current or output: CURR:PROT:DEL:STAR SCH, (@1)

Factors that influence how long the settings change or output load change may last include: difference between old output value and new output value, the current limit setting, and the load capacitance in CV mode or load inductance in CC mode. The delay required must be determined empirically; the power module programming-response time characteristics may be used as guidelines.

Note that the time it takes the output to go into CC mode varies - depending on the magnitude of the over-current condition compared to the current limit setting. For example, if the over-current is only slightly greater than the current limit setting, it may take several tens of milliseconds, depending on the power module type, for the output to set the CC status bit. If the over-current is significantly greater than the current limit setting, it may only take a few milliseconds or less, depending on power module type, for the output to set the CC status bit. To determine when the output will shut down, you must add the time it takes for the CC status bit to the over-current protection delay time. If the over-current persists beyond the sum of these two time intervals, the output will shut down.

Couple Output Protection

Protection coupling lets you disable all output channels when a protection condition occurs on a single output channel. To couple output protection:

Front Panel:	SCPI Command:
Select Protect\Couple . Check the Enable Coupling box and press Select.	To enable output protection coupling: OUTP:PROT:COUP ON

Output Watchdog Timer

The output watchdog timer causes all outputs to go into protection mode if there is no SCPI I/O activity on the remote interfaces (USB, LAN, GPIB) within the user-specified time period. Note that the watchdog timer function is NOT reset by activity on the front panel or when using the Web server – the outputs will still shut down after the time period has elapsed..

After the time period has expired, the outputs will be disabled, but the programmed output state is not changed. The PROT bit in the status questionable register as well as the PROT indicator on the front panel will be set.

The watchdog delay can be programmed from 1 to 3600 seconds in 1 second increments. As shipped from the factory, the watchdog timer is set to disable the outputs 60 seconds after all IO activity has ceased.

The watchdog state and delay settings are volatile, but can be saved and recalled as part of the instrument state. A watchdog protect can be cleared as described under “Clear Output Protection Functions”.

Front Panel:	SCPI Command:
Select Protect\Wdog	To enable the output watchdog timer:
Check Enable Watchdog to enable the watchdog timer.	<code>OUTP:PROT:WDOG ON</code>
Enter a value in the Watchdog Delay box and press Select.	To set the output watchdog timer to 600 seconds:
	<code>OUTP:PROT:WDOG:DEL 600</code>

Set the Oscillation Protection

NOTE

This information applies to Agilent Models N678xA SMU only.

If open sense leads or capacitive loads outside the allowable range cause the output to oscillate, the oscillation protection function detects the oscillation and latches the output off. The condition is announced on the front panel by the OSC status annunciator.

Front Panel:	SCPI Command:
Select Protect\OSC .	To enable oscillation protection for output 1:
Check the OSC box and press Select.	<code>VOLT:PROT:OSC ON, (@1, 2)</code>

Clear Output Protection Functions

If an over-voltage, over-current, over-temperature, power-fail condition, power-limit condition, protection condition, or inhibit signal occurs, the power system turns off the affected output channel. The appropriate operating status indicator on the front panel will be on. To clear the protection function and restore normal operation, first remove that condition that caused the protection fault. Then, clear the protection function as follows:

Front Panel:	SCPI Command:
Select Protect\Clear .	To clear a protection fault on output 1:
Select the Clear button.	<code>OUTP:PROT:CLE (@1)</code>

External Data Logging

NOTE

The external data log function is only available on mainframes with firmware revision D.01.09 and up. It cannot be programmed from the front panel.

The power system has an external data logger (ELOG) function that lets you log voltage and current measurements from all four outputs directly to an internal FIFO (first-in, first-out) buffer. Note that this buffer is only large enough to hold about 20 seconds of accumulated measurements. The following table lists this, along with some other restrictions that apply to the external data logger.

Function	External Data Logger
Data viewing	No front panel view or front panel control. Data must be exported to a spreadsheet.
Data storage	Buffers measurements for about 20 seconds and requires that the computer periodically reads measurements to prevent the internal buffer from overflowing. The computer needs to provide the data storage function.
Measurement resources	Run independently on each output. Some outputs can be running an external data log, while the remaining outputs can be used in front panel control or used for other SCPI functions.
Measurement functions	If a power module has only one measurement converter, then either voltage or current, but not both, can be logged.
Logging rate	Up to 102.4 microseconds for one parameter with data format set to real.

Briefly, to make external data log measurements:

- Select the measurement functions and ranges.
- Specify the measurement integration period.
- Select the trigger source.
- Trigger the data logger.
- Retrieve the data log measurement.

The external data logger function cannot be programmed from the front panel.

Select the Measurement Functions and Ranges

The following commands select a measurement function:

Front Panel:	SCPI Command:
Not Available	To enable voltage or current measurements: <code>SENS:ELOG:FUNC:VOLT ON, (@1)</code> <code>SENS:ELOG:FUNC:CURR ON, (@1)</code> To enable min/max measurements: <code>SENS:ELOG:FUNC:VOLT:MINM ON, (@1)</code> <code>SENS:ELOG:FUNC:CURR:MINM ON, (@1)</code>

If a power module has simultaneous measurements (see chapter 1, “Model Differences”), you can enable BOTH voltage and current measurements on the same output channel. Power modules that do not have simultaneous measurement capability cannot externally log both voltage and current.

Some power modules also have multiple measurement ranges. Selecting a lower measurement range provides greater measurement accuracy, provided that the measurement does not exceed the range. To select lower measurement ranges, use:

Front Panel:	SCPI Command:
Not Available.	To set the 5 V measurement range: SENS:ELOG:VOLT:RANG 5, (@1)
	To set the 1 A measurement range: SENS:ELOG:CURR:RANG 1, (@1)

Seamless Measurements

Seamless voltage and current measurement autoranging is available on Agilent Models N6781A and N6782A. This enables a wide dynamic measurement range with no data lost across ranges. Autoranging does not include the 10 µA range, which must be selected manually.

Front Panel:	SCPI Command:
Not Available	To enable seamless elog autoranging: SENS:ELOG:VOLT:RANG:AUTO ON, (@1) SENS:ELOG:CURR:RANG:AUTO ON, (@1)

Specify the Integration Period

The integration period can be set from a minimum of 102.4 microseconds to a maximum of 60 seconds.

Front Panel:	SCPI Command:
Not Available	To set an integration period of 600 microseconds: SENS:ELOG:PER 600E-6, (@1)

During the integration period, data log samples are averaged, and the minimum and maximum values are tracked. At the end of each integration period the average, minimum, and maximum values are added to the internal FIFO buffer.

Although the absolute minimum integration period is 102.4 microseconds, the actual minimum varies as a function of the number of parameters that are being logged. The actual minimum is 102.4 microseconds times the number of parameters being logged at each interval. Note that you can measure up to 4 parameters with the time interval resolution set to 20 microseconds, and up to 8 parameters with the resolution set to 40 microseconds.

- 102.4 microseconds:** 1 parameter (voltage or current)
- 204.8 microseconds:** 2 parameters (voltage+current)
- 409.6 microseconds:** 4 parameters (voltage+min+max+current) with 20 μ s time interval resolution
- 409.6 microseconds:** Up to 8 parameters with 40 μ s time interval resolution

You can change the time interval resolution as follows:

Front Panel:	SCPI Command:
Not Available	To set the resolution to 20 microseconds: SENS:SWE:TINT:RES RES20, (@1) To set the resolution to 40 microseconds: SENS:SWE:TINT:RES RES40, (@1)

If the specified integration period is at or near the minimum logging intervals, the data format must be specified as binary. If binary format is not specified, the data will be in ASCII format and the minimum logging intervals will typically be up to five times longer than what can be achieved with binary format.

Front Panel:	SCPI Command:
Not Available	To set the data format to binary: FORM[:DATA] REAL

Select the Data Logger Trigger Source

The TRIGger:ELOG command generates an immediate trigger regardless of the trigger source. Unless you are using this command, select a trigger source from the following:

- BUS** Selects GPIB device trigger, *TRG, or <GET> (Group Execute Trigger).
- EXternal** Selects any pin configured as a trigger input as the trigger source.
- IMMediate** Selects the immediate trigger source. This triggers the data logger immediately when initiated.
- PIN<n>** Selects a pin on the digital port. <n> specifies the pin number. The pin must be configured as a Trigger Input to be used as a trigger source (see Appendix C).

Use the following commands to select one of the available trigger sources:

Front Panel:	SCPI Command:
Not Available	TRIG:ELOG:SOUR BUS, (@1) or TRIG:ELOG:SOUR IMM, (@1) or TRIG:ELOG:SOUR EXT, (@1) or TRIG:ELOG:SOUR PIN<n>, (@1)

Initiate and Trigger the Data Logger

When the power system is turned on, the trigger system is in the Idle state. In this state, the trigger system is disabled, ignoring all triggers. The INITiate command enables the measurement system to receive triggers. To initiate and trigger the external data log:

Front Panel:	SCPI Command:
Not Available	To initiate data log measurements: INIT:ELOG (@1)
	To trigger the data logger: TRIG:ELOG (@1)

If the trigger source is BUS, you can also program *TRG or <GET> to trigger the data logger.

When triggered, the data logger starts placing data in the internal measurement buffer. Because the buffer is only large enough to hold 20 seconds of accumulated measurement your PC application must periodically retrieve (or fetch) the data from this buffer.

Periodically Retrieve the Data log Measurement

Each FETCh command returns number of requested records of the data in the buffer and removes them, making room available for more data. The measurement continues until it is aborted.

Front Panel:	SCPI Command:
Not Available	To retrieve a maximum of 1000 records: FETC:ELOG? 1000, (@1)

ASCII data (the default format) is returned as comma-separated ASCII numeric data sets of average/min/max values terminated by a newline. ASCII queries can only fetch data from one channel at a time.

Binary data is returned as a comma-separated list of data for each channel requested. The data for each channel is a definite length binary block, with the byte order specified by the FORMat:BORDER command.

Terminate the Measurement

Front Panel:	SCPI Command:
Not Available	To abort the external data logger: ABOR:ELOG (@1)

System-Related Operations

Self-Test

A *power-on* self-test occurs automatically when you turn on the power system. This test assures you that the instrument is operational. If the self-test is successful, the power system will continue to operate normally. If the self-test fails, the front panel **Err** indicator comes on. Press the Error key to display the list of errors on the front panel. Refer to the Service Guide for further information.

Front Panel:	SCPI Command:
Cycle AC power.	*TST?

Instrument Identification

For Agilent N6700 mainframes, you can return the model number, serial number, firmware revision, backup and active firmware. For power modules, you can return the model number, serial number, installed options, voltage, current and power rating.

Front Panel:	SCPI Command:
Select System\About\Frame .	*IDN?
or	SYST:CHAN:MOD? (@1)
Select System\About\Module .	SYST:CHAN:OPT? (@1)
	SYST:CHAN:SER? (@1)

Instrument State Storage

The power system has two storage locations in non-volatile memory to store instrument states. The locations are numbered 0 and 1. Any state previously stored in the same location will be overwritten.

Front Panel:	SCPI Command:
Select States\SaveRecall .	To save a state:
In the SaveRecall field, enter a location from 0 to 1, and press Select. Select Save to save the state or Recall to recall a state.	*SAV <n>
	To recall a state:
	*RCL <n>

When shipped from the factory, the power system is configured to automatically recall the reset (*RST) settings at power-on. However, you can configure the power system to use the settings stored in memory location 0 at power-on.

Front Panel:	SCPI Command:
Select States\PowerOn .	OUTP:PON:STAT RCL0
Select Recall State 0, then press Select.	

Output Groups

NOTE

Output grouping does not apply to Agilent Models N678xA SMU.

Output channels can be configured or “grouped” to create a single output with higher current and power capability. Almost all instrument functionality is supported by grouped channels, including voltage and current programming, measurements, status, step and list transients. The following conditions apply for grouped channels:

- Up to four output channels can be grouped per mainframe.
- Output channels that are grouped must also be connected in parallel as described in Chapter 2.
- Grouped channels do not have to be adjacent, but they must have identical model numbers and options installed.
- The maximum output current is the sum of the maximum of each channel in the group.
- Low current measurement ranges should not be used with grouped channels, otherwise a measurement overload error will occur. Low current output ranges, however, *can* be used.
- Over-current protection delay has a slightly slower response time (~10 ms) and slightly less resolution than an ungrouped channel.
- When output channels have been grouped, they are addressed using the channel number of the **lowest** channel in the group.
- Power limiting should not be used when Agilent N673xB, N674xB, and N677xA power modules are grouped. Refer to Appendix C.

Front Panel:	SCPI Command:
Select System\Groups . In the matrix that appears, select the channels you want to group. Each row defines a separate group.	To configure a group of channels: SYST:GRO:DEF (@2, 3, 4) This groups channels 2 through 4. To address the group, use channel 2.

To return grouped channels back to an ungrouped state, first remove the parallel connections between channels and proceed as follows:

Front Panel:	SCPI Command:
Select System\Groups . In the matrix, place each output channel in its own separate group.	To ungroup all channels: SYST:GRO:DEL:ALL

Reboot the unit for the grouping or ungrouping changes to take effect.

Front Panel:	SCPI Command:
Cycle AC power.	SYST:REB

Front Panel Keys

Lockout

You can lock the front panel keys to prevent unwanted control of the instrument from the front panel. This is the most secure way of locking the front panel keys because you need a password to unlock the front panel. The lockout setting is saved in non-volatile memory so that the front panel remains locked even after AC power is cycled.

Front Panel:	SCPI Command:
Select System\Preferences\Lock In the dialog box, enter the password to unlock the front panel. Then select Lock. The menu to unlock the front panel appears every time a key is pressed. Enter the password to unlock the front panel.	Not Available

NOTE

If the password is lost, the SYSTem:PASSword:FPANel:RESet command can reset the front panel lockout password. Refer to the Programmer's Reference Help file on your Agilent N6700 Product Reference CD for more information.

The SYSTem:COMMunicate:RLState RWLock command can also lock and unlock the front panel. This command is completely independent of the front panel lockout function. If you use this command to lock the front panel, the front panel will be unlocked when AC power is cycled.

Keys

You can enable or disable the front panel key clicks.

Front Panel:	SCPI Command:
Select System\Preferences\Keys Check Enable key clicks to enable key clicks. Uncheck to disable key clicks.	Not Available

You can configure the On/Off key to enable or disable ALL outputs.

Front Panel:	SCPI Command:
Select System\Preferences\Keys . Check On/Off key affects all channels. The ON/Off key will now be active on ALL channels.	Not Available

Front Panel Display

Screen Saver

The power system has a front panel screen saver that significantly increases the life of the LCD display by turning it off during periods of inactivity. The delay can be set from 30 to 999 minutes in 1 minute increments. As shipped from the factory, the screen saver comes on one hour after activity on the front panel or interface has ceased.

When the screen saver is active, the front panel display turns off, and the LED next to the Line switch changes from green to amber. To restore the front panel display, simply press one of the front panel keys. The first action of the key turns the display on. Subsequently, the key will revert to its normal function.

If the Wake on I/O function is selected, the display is restored whenever there is activity on the remote interface. This also resets the timer on the screen saver. As shipped, Wake on I/O is active.

Front Panel:	SCPI Command:
Select System\Preferences\Display\Saver Enable or disable the screen saver by checking or unchecking the Screen Saver checkbox. Then Press Select. Enter a value in minutes in the Saver Delay field to specify the time when the screen saver will activate. Check Wake on I/O to activate the display with I/O bus activity.	Not Available.

Contrast

You can set the contrast of the front panel display to compensate for ambient lighting conditions. The contrast can be set from 0% to 100% in increments of 1%. As-shipped, the contrast is set to 50%.

Front Panel:	SCPI Command:
Select System\Preferences\Display\Contrast Enter a contrast value in the Contrast box. Then Press Select.	Not Available.

View

You can specify how the output channels are displayed at turn on.

Front Panel:	SCPI Command:
Select System\Preferences\Display\View Check 1-channel to display channel one. Check 4-channel to display all channels.	To display all channels: DISP:VIEW METER4

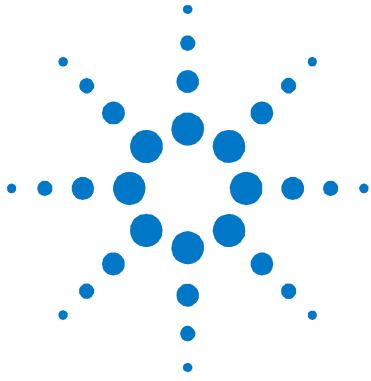

Appendix A Specifications

Agilent N6700B, N6701A, N6702A MPS Mainframes	100
---	-----

This appendix lists the supplemental characteristics of the Agilent N6700 Modular Power System. A dimensional line drawing of the mainframe is included at the end of the chapter.

Supplemental characteristics are not warranted but are descriptions of performance determined either by design or type testing. All supplemental characteristics are typical unless otherwise noted.

NOTE

Complete specifications and supplemental characteristics information for all power modules are included in the Agilent N6700 Modular Power System Family Specifications Guide. This document is available on the Agilent N6700 Product Reference CD that is shipped along with your instrument as well as on the web at www.agilent.com/find/N6700.

Agilent N6700B, N6701A, N6702A MPS Mainframes

Supplemental Characteristics

N6700B, N6701A, N6702A	
Maximum Power Available for Modules: (sum of total module output power)	
	400 W (for N6700B mainframes) 600 W (for N6701A mainframes) 1200 W (for N6702A mainframes)
Internal Flash Memory:	8 Mbyte
Protection Response Characteristics:	
INH input	5 μ s from receipt of inhibit to start of shutdown
Fault on coupled outputs	< 10 μ s from receipt of fault to start of shutdown
Command Processing Time: \leq 1 ms from receipt of command to start of output change	
Digital Control Characteristics:	
Maximum voltage ratings	+16.5 VDC/– 5 VDC between pins (pin 8 is internally connected to chassis ground).
Pins 1 and 2 as FLT output	Maximum low-level output voltage = 0.5 V @ 4 mA Maximum low-level sink current = 4 mA Typical high-level leakage current = 1 mA @ 16.5 VDC
Pins 1 - 7 as digital/trigger outputs (pin 8 = common)	Maximum low-level output voltage = 0.5 V @ 4 mA; 1 V @ 50 mA; 1.75 V @ 100 mA Maximum low-level sink current = 100 mA Typical high-level leakage current = 0.8 mA @ 16.5 VDC
Pins 1 - 7 as digital/trigger inputs and pin 3 as INH input (pin 8 = common)	Maximum low-level input voltage = 0.8 V Minimum high-level input voltage = 2 V Typical low-level current = 2 mA @ 0 V (internal 2.2k pull-up) Typical high-level leakage current = 0.12 mA @ 16.5 VDC
Interface Capabilities:	
GPIB	SCPI - 1993, IEEE 488.2 compliant interface
LXI Compliance	Class C (only applies to units with LXI label on front panel)
USB 2.0	Requires Agilent IO Library version M.01.01 or 14.0 and up
10/100 LAN	Requires Agilent IO Library version L.01.01 or 14.0 and up
Built-in Web server	Requires Internet Explorer 7+ or Firefox 2+
Regulatory Compliance:	
EMC	Complies with European EMC Directive for test and measurement products. <ul style="list-style-type: none"> • IEC/EN 61326-1 • CISPR 11, Group 1, class A • AS/NZS CISPR 11 • ICES/NMB-001 Complies with Australian standard and carries C-Tick mark. This ISM device complies with Canadian ICES-001. Cet appareil ISM est conforme à la norme NMB-001 du Canada.
Safety	Complies with European Low Voltage Directive and carries the CE-marking. Conforms to UL 61010-1 and CSA C22.2 61010-1.

Supplemental Characteristics (continued)

N6700B, N6701A, N6702A

Environmental Conditions

Operating environment	Indoor use, installation category II (for AC input), pollution degree 2
Temperature range	0°C to 55°C (output current is derated 1% per °C above 40°C ambient temperature)
Relative humidity	Up to 95%
Altitude	Up to 2000 meters
Storage temperature	-30°C to 70°C

Acoustic Noise Declaration:

This statement is provided to comply with the requirements of the German Sound Emission Directive, from 18 January 1991.	Sound Pressure Lp <70 dB(A), At Operator Position, Normal Operation, According to EN 27779 (Type Test). Schalldruckpegel Lp <70 dB(A), Am Arbeitsplatz, Normaler Betrieb, Nach EN 27779 (Typprüfung).
--	--

Output Terminal Isolation:

Maximum Rating	No output terminal may be more than 240 VDC from any other terminal or chassis ground.
N6781A Note:	When using the AUX measurement input terminals on Model N6781A, no output or input terminal may be more than ±60 VDC from any other terminal or chassis ground.

AC Input:

Input Ratings	~ 100 VAC – 240 VAC; 50/60/400Hz
Power Consumption	1000 VA (N6700B) 1440 VA (N6701A) 1440 VA (N6702A @ < 180 VAC input) 2200 VA (N6702A @ > 180 VAC input)
Power Factor ^{NOTE 1}	0.99 @ nominal input and rated power
Fuse	Internal fuse - not customer accessible.
N6702A Note:	AC mains circuits rated at 100-180 VAC cannot supply enough current to power the N6702A mainframe when operated at its full rated power. When connected to a 100-180 VAC mains, internal circuits will limit the power available to modules to 600 W maximum.

Net Weight:

N6700B with 4 power modules	12.73 kg / 28 lbs.
N6701A with 4 power modules	11.82 kg / 26 lbs.
N6702A with 4 power modules	14.09 kg / 31 lbs.
Single power module (typical)	1.23 kg / 2.71 lbs

Dimensions:

Refer to the outline diagrams on the following page.

¹ Under full load at 400 Hz, power factor drops from 0.99 @ 120 VAC to as low as 0.76 @ 265 VAC. Power factor degrades further under no load conditions.

Outline Diagram

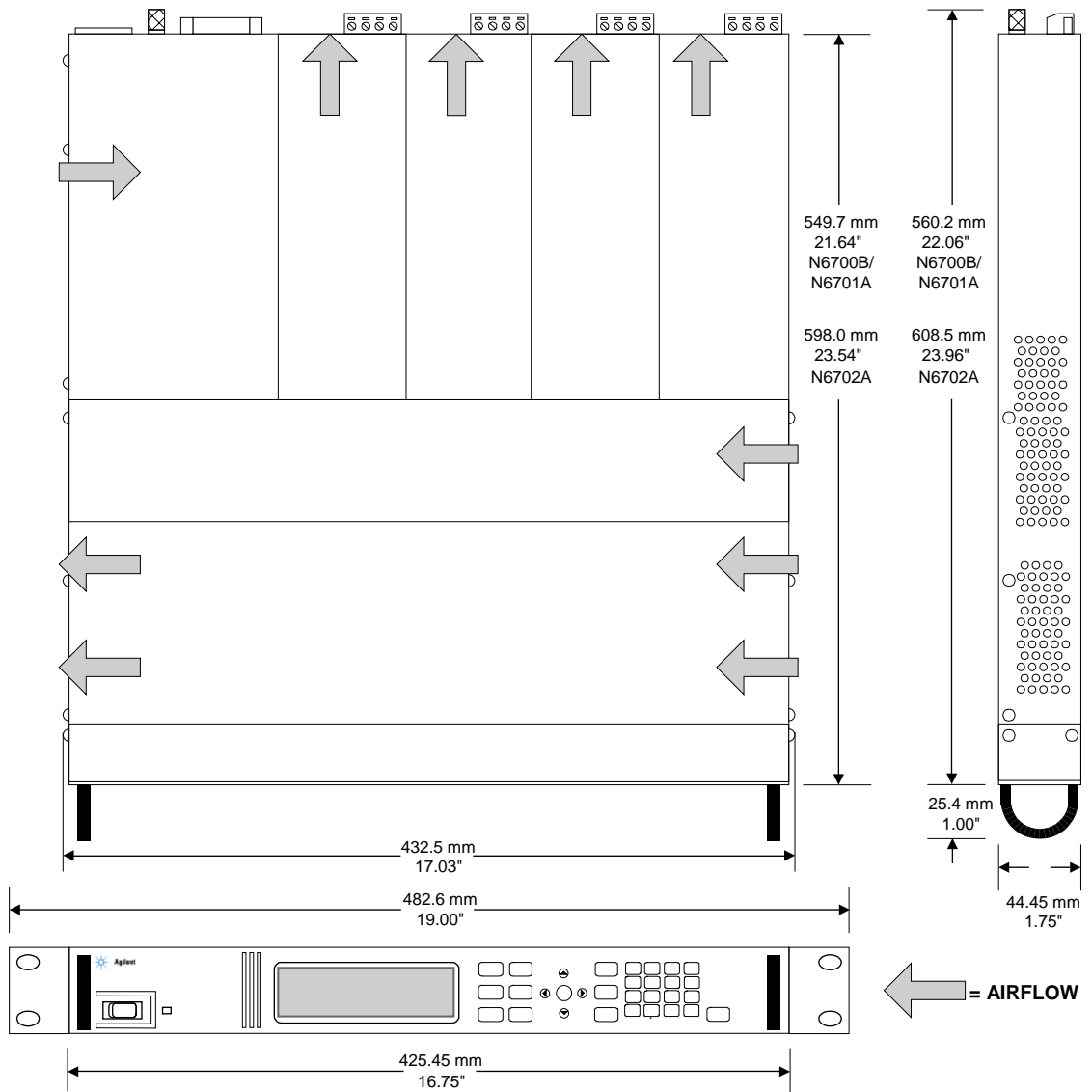

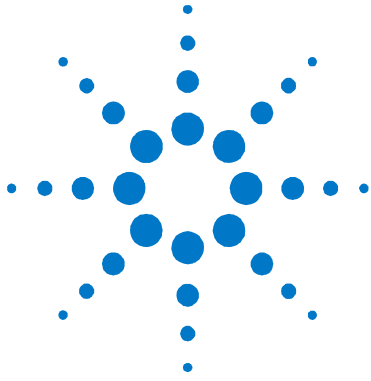

Appendix B Using the Digital Port

Digital Control Port	104
Configuring the Digital Control Port	105

A Digital Control Port consisting of seven I/O pins is provided to access various control functions. Each pin is user-configurable. The following control functions are available for the I/O pins:

- Bi-directional Digital I/O
- Digital Input only
- External Trigger
- Fault Output
- Inhibit Input
- Output State (see Appendix D)

NOTE

Earlier Agilent N6700A mainframes use a 4-pin connector instead of the 8-pin connector available on the N6700B, N6701A, and N6702A mainframes. Refer to the Service Guide for information on pin functionality of the 4-pin connector.

Digital Control Port

An 8-pin connector and a quick-disconnect connector plug are provided on each instrument for accessing the five digital control port functions.

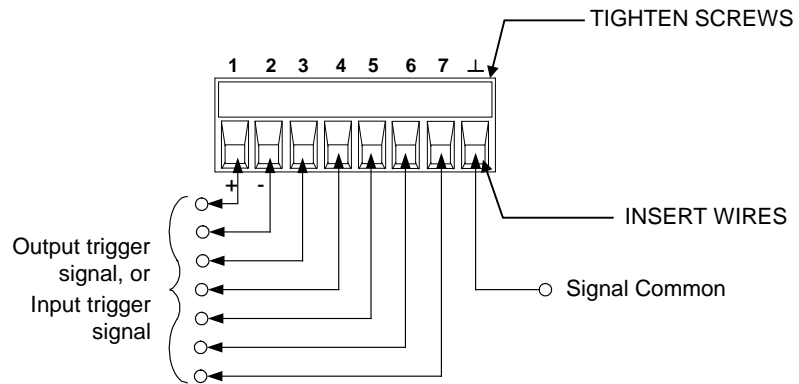

The digital control connector accepts wires sizes from AWG 14 to AWG 30. Note that wire sizes smaller than AWG 24 are not recommended. Disconnect the connector plug to make your wire connections.

NOTE

It is good engineering practice to twist and shield all signal wires to and from the digital connectors. If shielded wire is used, connect only one end of the shield to chassis ground to prevent ground loops.

The following chart describes the possible pin configuration for the digital port functions. For a complete description of the electrical characteristics of the digital I/O port, refer to Appendix A.

Pin Function	Available configurable pins
Digital I/O and Digital In	Pins 1 through 7
External Trigger In/Out	Pins 1 through 7
Fault Out	Pins 1 and 2
Inhibit In	Pin 3
Output State	Pins 4 through 7
Common (⊥)	Pin 8

In addition to the configurable pin functions, the active signal polarity for each pin is also configurable. When Positive polarity is selected, a logical true signal is a voltage high at the pin. When Negative polarity is selected, a logical true signal is a voltage low at the pin.

For a complete description of the electrical characteristics of the digital port, see Appendix A.

Configuring the Digital Control Port

Bi-directional Digital I/O

Each of the seven pins can be configured as general purpose bi-directional digital inputs and outputs. The polarity of the pins can also be configured. Pin 8 is the signal common for the digital I/O pins. Data is programmed according to the following bit assignments:

Pin	7	6	5	4	3	2	1
Bit weight	6 (msb)	5	4	3	2	1	0 (lsb)

To configure the pins for digital I/O:

Front Panel:	SCPI Command:
Select System\IO\DigPort\Pins .	To configure the pin function: DIG:PIN<1-7>:FUNC DIO
Select a pin in the Pin field.	
In the Function field, select Dig I/O.	To configure pin polarity: DIG:PIN<1-7>:POL <pol>
In the Polarity field, select either Positive or Negative.	
To send data to the pins, select System\IO\DigPort\Data .	To send data to the pins: DIG:OUTP:DATA <data>
Select the Data Out field and enter the binary word.	

The digital I/O pin can be used to control both relay circuits as well as digital interface circuits. The following figure illustrates typical relay circuits as well as digital interface circuit connections using the digital I/O functions.

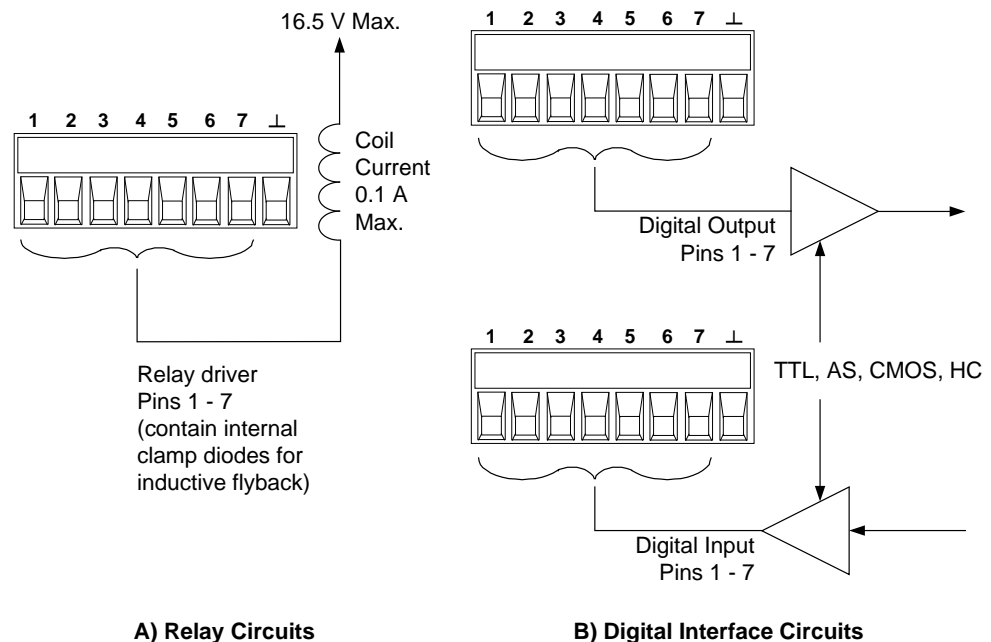

Digital Input

Each of the seven pins can be configured as digital input only. The polarity of the pins can also be configured. Pin 8 is the signal common for the digital input pins. The pin status reflects the true condition of the external signal that is applied to the pin. The pin state is not affected by the value of the binary output word.

To configure the pins for digital input only:

Front Panel:	SCPI Command:
Select System\IO\DigPort\Pins . Select a pin in the Pin field.	To configure the pin function: DIG:PIN<1-7>:FUNC DIMP
In the Function field, select Dig In. In the Polarity field, select either Positive or Negative.	To configure pin polarity: DIG:PIN<1-7>:POL <pol>
To read the data from the pins, select System\IO\DigPort\Data . The input data is displayed as a binary number in the Data In field.	To read the pin data: DIG:INP:DATA?

External Trigger

Each of the seven pins can be configured as either trigger inputs or trigger outputs. The polarity of the pins can also be configured. When you program trigger polarity, POSitive means a rising edge and NEGative means a falling edge. Pin 8 is the signal common for the trigger pins.

When configured as a trigger input, you can apply either a negative-going or a positive-going pulse to the designated trigger input pin. The trigger latency is 5 microseconds. The minimum pulse width is 4 microseconds for positive-going signals, and 10 microseconds for negative-going signals. The pin's polarity setting determines which edge generates a trigger-in event.

When configured as a trigger output, the designated trigger pin will generate a 10 microsecond-wide trigger pulse in response to a trigger event. Depending on the polarity setting, it can be either positive-going or negative-going when referenced to common.

Front Panel:	SCPI Command:
Select System\IO\DigPort\Pins , Select a pin in the Pin field. In the Function field, select either Trig In or Trig Out. In the Polarity field, select either Positive or Negative.	To select the trigger output function for pin 1: DIG:PIN1:FUNC TOUT To select the trigger input function for pin 2: DIG:PIN2:FUNC TINP To select the trigger polarity: DIG:PIN<1-7>:POL <pol>

Fault Output

Pins 1 and 2 can be configured as a fault-output pair. The polarity of pin 1 can also be configured. Pin 1 is the Fault output; pin 2 is the common for pin 1. Note that pin 2 must also be connected to pin 8.

The Fault Output function enables a fault condition on any channel to generate a fault signal on the Digital Control port. The following conditions will generate a fault event: over-voltage, over-current, over-temperature, inhibit signal, power-fail condition, or on some models, a power-limit condition.

Both pins 1 and 2 are dedicated to this function. This provides for an optically-isolated output. Pin 2's function is ignored. Note that the Fault output signal remains latched until the fault condition is cleared. You must also clear the protection circuit.

Front Panel:	SCPI Command:
Select System\IO\DigPort\Pins .	To configure the Fault function: DIG:PIN1:FUNC FAUL
Select pin 1, then Function, then Fault Out. In the Polarity field, select either Positive or Negative.	To select the fault output polarity: DIG:PIN1:POL <pol>

Inhibit Input

Pin 3 can be configured as a remote inhibit input. The polarity of pin 3 can also be configured. Pin 8 is the common for pin 3.

The Inhibit Input function lets an external input signal control the output state of all of the output channels in the mainframe. The signal latency is 5 microseconds. Pin 3 can be programmed for the following Inhibit modes, which are stored in non-volatile memory:

- LATCHing** Causes a logic-true transition on the Inhibit input to disable all outputs. The outputs will remain disabled after the inhibit signal is received.
- LIVE** Allows the enabled outputs to follow the state of the Inhibit input. When the Inhibit input is true, the outputs are disabled. When the Inhibit input is false, the outputs are re-enabled.
- OFF** The Inhibit input is ignored.

Front Panel:	SCPI Command:
Select System\IO\DigPort\Pins .	To configure the Inhibit function: DIG:PIN3:FUNC INH
Select pin 3, then Function, then Inhibit In. In the Polarity field, select either Positive or Negative.	To select the inhibit input polarity: DIG:PIN3:POL <pol>
Select Protect\Inhibit .	To latch the Inhibit signal: OUTP:INH:MODE LATC
Select either Latching or Live.	To set the Inhibit signal live: OUTP:INH:MODE LIVE
To disable the Inhibit signal, select Off	To disable the Inhibit signal: OUTP:INH:MODE OFF

Fault/Inhibit System Protection

The following figure illustrates some ways that you can connect the Fault/Inhibit pins of the connector.

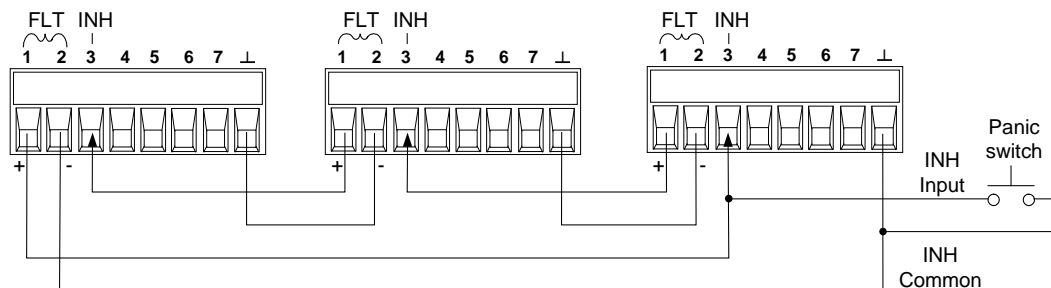

As shown in the figure, when the Fault outputs and Inhibit inputs of several mainframes are daisy-chained, an internal fault condition in one of the mainframes will disable all of them without intervention by either the controller or external circuitry.

You can also connect the Inhibit input to a manual switch or external control signal that will short the Inhibit pin to common whenever it is necessary to disable all output channels in the mainframe. Negative polarity must be programmed for all pins in this case. You can also use the Fault output to drive an external relay circuit or signal other devices whenever a user-definable fault occurs.

Clearing a System Protection Fault

To restore all instruments to a normal operating condition when a fault condition occurs in a daisy-chained system protection configuration, two fault conditions must be removed:

1. The initial protection fault or external Inhibit signal.
2. The subsequent daisy-chained fault signal (which is sourced by the Inhibit signal).

NOTE

Even when the initial fault condition or external signal is removed, the Inhibit fault signal is still active and will continue to shut down the outputs of all the mainframes.

To clear the daisy-chained fault signal if the operating mode of the Inhibit input is Live, simply clear the output protection on any ONE mainframe as explained in chapter 4. If the operating mode of the Inhibit input is Latched, turn off the Inhibit input on ALL mainframes individually. To re-enable the chain, re-program the Inhibit input on each mainframe to Latched mode.

Output State

Only pins 4 through 7 can be configured to control the output state. This function lets you connect multiple Agilent N6700 mainframes together and synchronize the output on/off sequence across mainframes. Refer to Appendix D for detailed information.

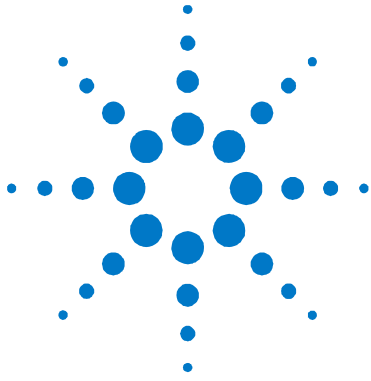

Appendix C Power Allocation

Power Limit Operation	110
Module Power Allocation	111

This appendix discusses the power allocation function.

For the majority of Agilent N6700 Modular Power System configurations, full power is available from all installed power modules. However, it is possible to configure a power system in which the combined ratings of the power modules exceed the power rating of the mainframe.

The power rating of Agilent N6700 mainframes is as follows:

- Agilent N6700A/B = 400 W
- Agilent N6701A = 600 W
- Agilent N6702A @ nominal 100 - 120 VAC = 600 W
@ nominal 200 - 240 VAC = 1,200 W

Note that the power system will continue to operate normally as long as the combined module output power is within the power rating of the mainframe.

Power Limit Operation

Mainframe Power Limit

If the combined power drawn from all of the power modules exceeds the mainframe's power rating, a power fault protection event will occur. This causes ALL outputs to turn off and remain off until a protection clear command is given. This is explained in chapter 4 under "Clear Output Protection Functions". A status bit (PF) will indicate that a power fault protection event has occurred.

The power allocation function lets you programmatically limit the power that can be sourced from individual power modules, thereby preventing the combined power from exceeding the mainframe's rated output power and causing all the outputs to turn off.

NOTE

For N6702A mainframes operating at 100-120 VAC nominal, the sum of the channel power limit settings cannot exceed 600W due to a restriction on the AC line current. There is no restriction when operating at 200-240 VAC nominal.

Module Power Limit

When the power limit has been set to a value less than the maximum rating on a power module, and either the output voltage or the output current increases to a point where the module exceeds the power limit setting, the module's power limit function will activate. If the power limit is left at the maximum rating, then the power module will not enable its power limit function.

On Agilent N673xB, N674xB, and N677xA power modules, the power limit function will turn the output off after a power limit condition persists for about 1 millisecond. A status bit (CP+) will indicate that the output has been turned off because of a power limit condition. To restore the output, you must first adjust the load so that it draws less power. Then you must clear the protection function as explained in chapter 4 under "Clear Output Protection Functions". Note that on these models, it may be preferable for some applications to use the current or voltage setting to limit the output power so as to avoid turning the output off.

On Agilent N675xA, and N676xA power modules, the power limit function will limit the output power at its programmed setting. A status bit (CP+) will indicate that the output is in power limit mode. When the power drawn by the load is reduced below the power limit setting, the output automatically returns to normal operation - either constant voltage or constant current mode.

NOTE

Power limiting should not be used when Agilent N673xB, N674xB, and N677xA power modules are grouped. When these power modules are grouped, you must reset the power limit to its maximum rated value.

For Agilent Models N678xA SMU, the power limit function does not apply.

Module Power Allocation

The following commands program the module power limit function:

Front Panel:	SCPI Command:
Select Output\Advanced\Power . Enter a power limit for each output.	To set a power limit on output 1: POW:LIM 100, (@1)

To query the power limits that are set, send:

Front Panel:	SCPI Command:
Select Output\Advanced\Power . The power allocation for all output channels is displayed in the dialog boxes.	POW:LIM? (@1:4)

To return all output channels to their default settings, you can either cycle AC power or send the following commands:

Front Panel:	SCPI Command:
Select States\Reset	*RST or POW:LIM MAX, (@1:4)

NOTE

When an output channel is set to MAX, it returns to its maximum rated value, and the power limit function will not activate.

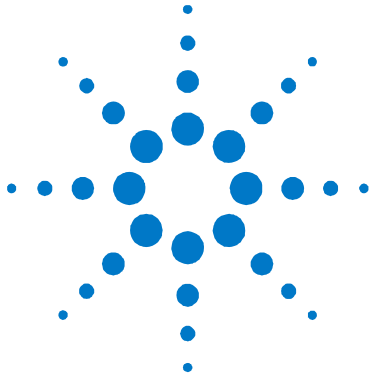

Appendix D

Output On/Off Synchronization

Synchronizing Output Turn-on Delays	114
Synchronizing Multiple Mainframes	117
Operation	118

This appendix discusses output on/off synchronization. This function lets you accurately synchronize output turn-on sequences by letting you specify a common delay offset, which serves as a reference point for the user-programmed turn-on delays.

This same reference point also makes it possible to connect multiple Agilent N6700-series mainframes together and program accurate turn-on sequences across multiple mainframes.

There is no need to specify a delay offset when outputs turn off. Outputs start executing their turn-off delays as soon as an output Off command is received.

For complete details on the SCPI commands discussed in this appendix, refer to the N6700 Programmer's Reference Help file included on the Agilent N6700 Product Reference CD. This CD-ROM is shipped along with your instrument.

Synchronizing Output Turn-on Delays

All N6700 Power Modules that are installed in an Agilent N6700 mainframe exhibit a minimum delay offset that applies from the time that a command to turn on the output is received until the output actually turns on. If you specify a user-programmed turn-on delay, this delay will be added to the minimum delay offset, resulting in a turn-on delay that is actually longer than the one you programmed. The minimum delay offset is shown in the following table.

Power Modules	Options and Mode	Minimum Delay Offset
N673xB, N674xB, N677xA	Without relays	32 ms
	With relay option 760	58 ms
N6751A, N6752A	Without relays	25 ms
	With relay option 760	51 ms
N6753A, N6754A	Without relays	18 ms
	With relay option 760	44 ms
N6761A, N6762A	Without relays	32 ms
	With relay option 760	58 ms
	Without relays; Current priority	23 ms
	With relay option 760; Current priority	45 ms
N6781A, N6782A	With turn-off mode set to Low Z	23.6 ms
	With turn-off mode set to High Z	22.8 ms

To determine which power modules are installed in your mainframe, select **System>About\Module** from the front panel. This identifies the power module and the installed options. If N676xA power modules are installed, send the `OUTP:PMODE?` query to determine if Current priority mode has been set.

To determine the actual turn-on delay between the “on” event (such as pressing the Output On key or sending an Output On command), you must add the programmed turn-on delay to the minimum delay offset as shown in the following example. In this example, if you program delay values of 10 ms, 20 ms, 30 ms, and 40 ms for output channels 1 through 4 respectively, the actual output delays will be 68 ms, 45 ms, 81 ms, and 72 ms for output channels 1 through 4.

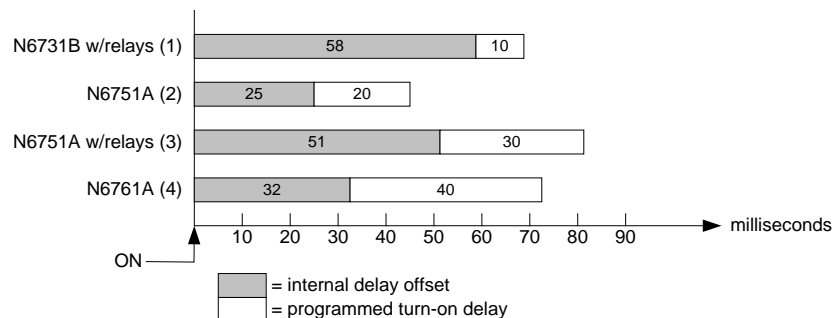

To synchronize power modules with *different* minimum delay offsets as shown above, you can specify a *common* delay offset parameter.

By setting the common delay offset to be greater than or equal to the largest minimum delay offset, you can synchronize the programmed turn-on delays as shown in the following example.

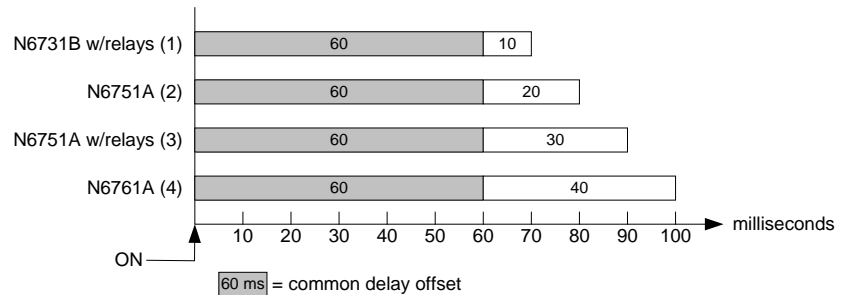

Since there will be an additional delay due to the common delay offset, you will need to account for the additional delay time. As shown in the previous example, if you program a common delay of 60 ms and user-programmed delays of 10 ms, 20 ms, 30 ms, and 40 ms for output channels 1 through 4, the actual output delays from the “on” event will be 70 ms, 80 ms, 90 ms, and 100 ms respectively.

Even though this 60 ms delay offset will be seen on all outputs, the additional delay time will not affect most applications because the relative delay times *between* output module turn-on will still be 10 ms, 20 ms, 30 ms, and 40 ms – the exact values originally specified.

NOTE

If you have previously characterized the minimum turn-on delays of the power modules that you are synchronizing and have incorporated this delay in your application program, you do not need to rewrite your test program. Your application will continue to work as before.

Procedure

To configure the output turn-on delays:

1. Enable the turn-on synchronization function on the mainframe.
2. Specify the output channels that will be synchronized or coupled.
3. Specify the user-programmed turn-on delay for each output channel that will be synchronized.
4. This step is required if you have power modules with *different* minimum delay offsets. Specify a common delay offset for all of the synchronized output channels. When the common delay offset completes, the user-programmed turn-on delays will start.

1. Enable the Synchronization Function

Output turn-on synchronization must be enabled on the mainframe.

Front Panel:	SCPI Command:
In the front panel menu, select Output \ Sequence \ Couple .	To enable, send: OUTP : COUP ON
Check the box labeled “Enable”.	To disable, send: OUTP : COUP OFF
To disable, uncheck the box.	

2. Specify which Output Channels will be Synchronized

Select the output channels that will be synchronized.

Front Panel:	SCPI Command:
In the front panel menu, select Output\Sequence\Couple . Check which channels will be coupled. To remove a channel, uncheck the box.	To specify a channel or channels: OUTP:COUP:CHAN 1,2,3,4

3. Specify the Turn-On Delays for each Output Channel

Turn-on delays can be specified for all coupled output channels. Any delay sequence can be implemented. There are no restrictions on what the sequence is or what channel comes up first.

Front Panel:	SCPI Command:
For channels 1, 2, 3, and 4, select Output\Sequence\Delay . Specify the Turn-on delay for each channel in seconds; then press Select.	Program a turn-on delays for channels 1 through 4: OUTP:DEL:RISE .01,(@1) OUTP:DEL:RISE .02,(@2) OUTP:DEL:RISE .03,(@3) OUTP:DEL:RISE .04,(@4)

4. Specify the Common Delay Offset

Specifying a common delay offset assures that the user-programmed turn-on delays will be synchronized to start at the completion of the common delay offset. Select the delay offset of the *slowest* power module in the mainframe and use that as the common delay offset.

Front Panel:	SCPI Command:
In the front panel menu, select Output\Sequence\Couple . The Max delay offset for this frame field displays the delay offset of the <i>slowest</i> power module in the frame. Enter the delay offset value of the <i>slowest</i> power module in the Delay offset field in milliseconds; then press Select.	To query the delay offset of the <i>slowest</i> power module in the mainframe (the maximum delay offset) in seconds: OUTP:COUP:MAX:DOFF? To specify the common delay offset for the mainframe in seconds: OUTP:COUP:DOFF .051

Note that you can program a common delay that is longer than the maximum delay offset of the mainframe. You may choose a longer value to make your program flexible for future configurations that may have power modules with longer delay offsets. However, if you program a value that is shorter than the maximum delay offset, you may experience improper synchronization across all outputs.

NOTE

There is no need to specify a delay offset when outputs turn off. Outputs start executing their turn-off delays as soon as an output Off command is received.

Synchronizing Multiple Mainframes

The output turn-on synchronization function can be used across multiple mainframes that have coupled output channels. Each mainframe that will be synchronized must have at least one coupled channel. Note that cross-frame synchronization must be enabled for any mainframe that contains synchronized output channels.

Procedure

1. Configure the output channels on each mainframe as described in steps 1 through 3 of the previous procedure.
2. This step is required if you have power modules with *different* minimum delay offsets. Specify a common delay offset for *all* of the synchronized output channels. This value must be the largest delay offset of all synchronized output channels regardless of the mainframe in which they are installed. This same value must be specified as the common delay offset for *each* mainframe.

Front Panel:	SCPI Command:
In the front panel menu of each mainframe, select Output\Sequence\Couple .	To specify the common delay offset for each mainframe in seconds: OUTP:COUP:DOFF .051
In the Delay offset field, enter the delay offset value of the <i>slowest</i> power module of <i>all</i> the mainframes in milliseconds; then press Select. The Max delay offset for this frame field displays the delay offset of the <i>slowest</i> power module in <i>this</i> frame.	To return the delay offset of the <i>slowest</i> power module in each mainframe (the maximum delay offset) in seconds: OUTP:COUP:MAX:DOFF?

3. Connect and configure the digital connector pins of the synchronized mainframes as described in the following section.

Digital Connections and Configuration

NOTE

Only pins 4 through 7 can be configured as synchronization pins. You cannot configure more than one ON couple and one OFF couple pin per mainframe. The polarity of the pins is not programmable.

The digital connector pins of the synchronized mainframes that contain coupled channels must be connected together as shown in the following figure. In this example, pin 6 will be configured as the output On control. Pin 7 will be configured as the output Off control. The ground or Common pins also need to be connected together.

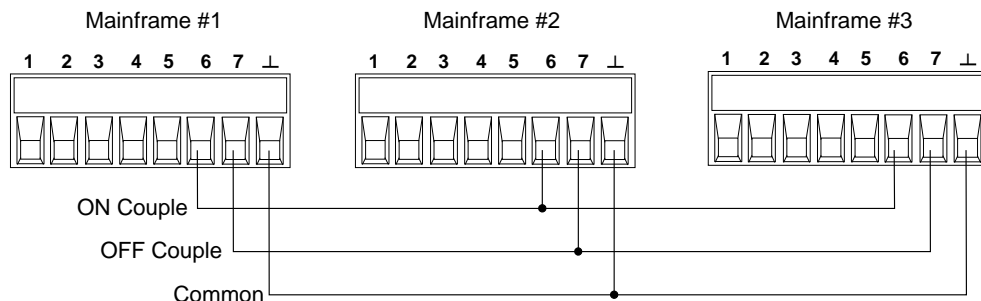

Only *two* of the digital connector pins on each mainframe can be configured as “ONCouple” and “OFFCouple” on each synchronized mainframe. The designated pins will function as both an input and an output, with a negative transition on one pin providing the synchronization signal to the other pins.

Front Panel:	SCPI Command:
For mainframe #1, select System\IO\DigPort\Pin6	To configure pin 6 of mainframe #1 as the ON control:
Select Function, then ONCouple.	DIG:PIN6:FUNC ONC
Select Pins , select pin 7, then select Function, then OFFCouple.	To configure pin 7 of mainframe #1 as the OFF control:
Repeat these steps for mainframes #2 and #3.	DIG:PIN7:FUNC OFFC
	Repeat these commands for mainframes #2 and #3.

Operation

Once configured and enabled, turning the output on or off on *any* coupled channel will cause *all* coupled channels on all configured mainframes to turn on or off according to their user-programmed delays. This applies to the front panel On/Off key, the Web server, and to SCPI commands.

If a mainframe has its ON/OFF key coupled (located in the **System\Preferences\Keys** menu), turning the output on or off on *any* coupled channel will cause all coupled channels as well as non-coupled channels *on that mainframe* to turn on or off.

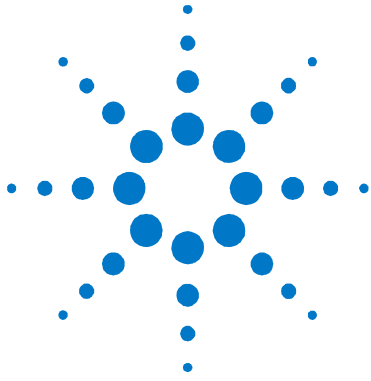

Appendix E

Source Operating Modes

Single Quadrant Operation	120
Agilent N678xA Multi-Quadrant Operation	122

This appendix discusses the difference between constant voltage and constant current operating modes, multiple output quadrant operation, and other advanced source functions.

Single Quadrant Operation

The Agilent N6700 Modular Power System can operate in either constant voltage (CV) or constant current (CC) over the rated output voltage and current. Constant voltage mode is defined as an operating mode in which the dc source maintains its output voltage at the programmed voltage setting in spite of changes in load, line, or temperature. Thus, when the load resistance changes, the output voltage remains constant while the output current changes to accommodate the change in load.

Constant current mode is defined as an operating mode in which the dc source maintains its output current at the programmed current limit in spite of changes in load, line, or temperature. Thus, when the load resistance changes, the output current remains constant while the output voltage changes to accommodate the change in load.

All DC power modules, except for Agilent Models N678xA SMU, are designed as *constant voltage* sources. This means that the specifications and operating characteristics are optimized for constant voltage mode operation. Note that these power modules cannot be programmed to operate in a specific mode. At turn-on, the operating mode will be determined by the voltage setting, current setting, **and** the load resistance. In the following figure, operating point 1 is defined by a fixed load line traversing the positive operating quadrant in the constant voltage region. Operating point 2 is defined by a fixed load line traversing the positive operating quadrant in the constant current region.

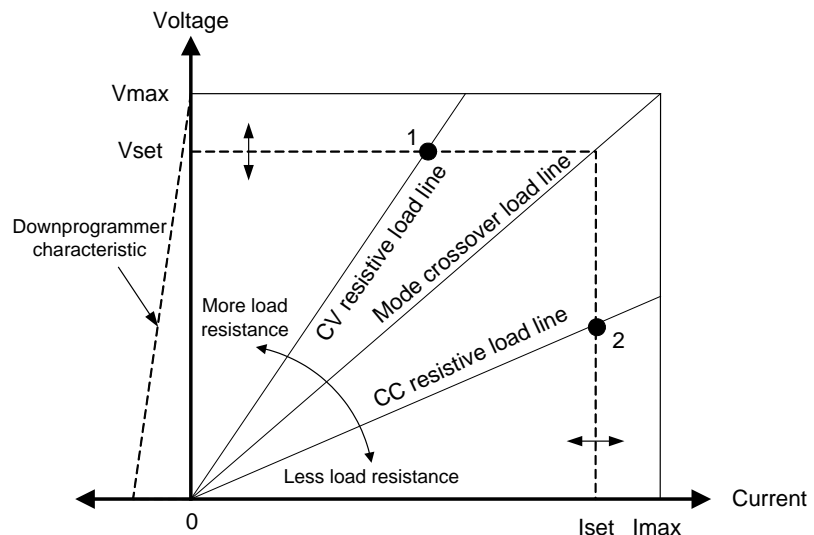

Autoranging

NOTE

Autoranging only applies to Agilent N675xA and N676xA power modules.

The following figure illustrates the autoranging output characteristic of the Agilent N675xA and N676xA power modules. Point 3 shows a situation in which the voltage and current settings are such that the operating locus is limited by the maximum output power boundary of the output. Depending on the power module, this may be greater than the output power rating of the module. In this situation, the output is not guaranteed to meet its operating specifications because it is operating in an area that is outside its specified power rating.

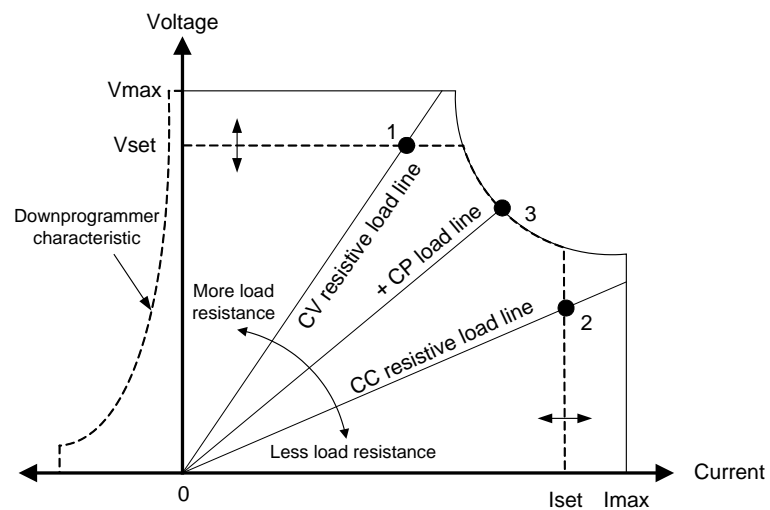

Downprogramming

As shown by the dashed line on the left in the figures, the power system is capable of sinking current over the output voltage range from zero volts to the rated voltage. This negative current sinking capability provides fast downprogramming of the output. The negative current is not programmable.

Agilent N678xA Multi-Quadrant Operation

Agilent Models N678xA SMU can be operated in either voltage or current priority mode. They can source as well as sink output power. Note that Agilent Models N6781A and N6782A operate only in the + Voltage quadrants.

Voltage Priority Mode

In voltage priority mode, the output voltage should be programmed to the desired positive or negative value. A positive current limit value should also be set. The current limit should always be set higher than the actual output current requirement of the external load. With tracking enabled, the negative current limit tracks the positive current limit setting. With tracking disabled, you can set different values for the positive and negative current limits.

The following figure shows the voltage priority operating locus of the power modules. The area in the white quadrants shows the output as a source (sourcing power). The area in the shaded quadrants shows the output as a load (sinking power).

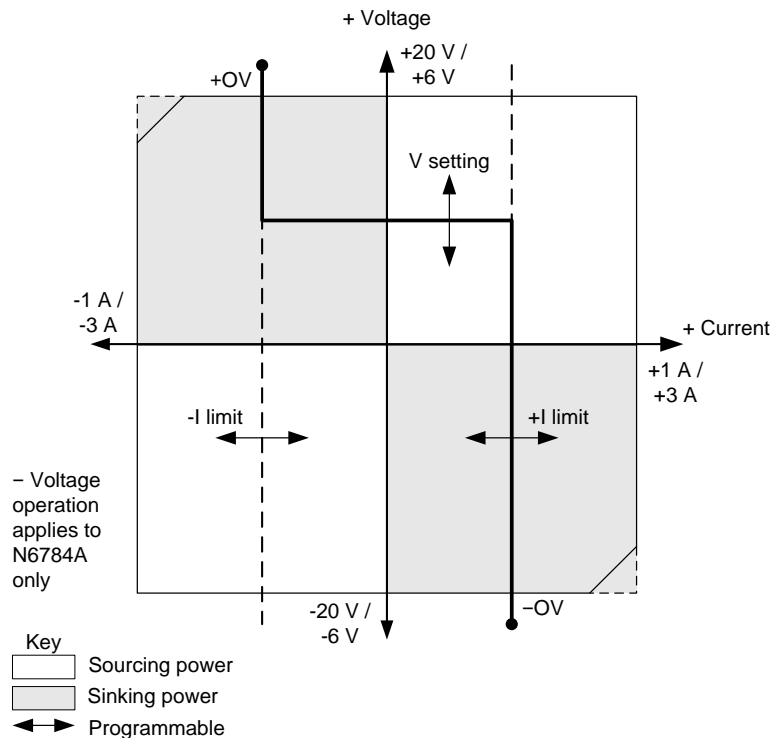

The heavy solid line illustrates the locus of possible operating points as a function of the output load. As shown by the horizontal portion of the line, the output voltage remains regulated at its programmed setting as long as the load current remains within the positive or negative current limit setting. A CV (constant voltage) status flag indicates that the output current is within the limit settings.

When the output current reaches either the positive or negative current limit, the unit no longer operates in constant voltage mode and the output voltage is no longer held constant. Instead, the power supply will now regulate the output current at its current limit setting. Either a LIM+ (positive current limit), or LIM- (negative current limit) status flag is set to indicate that a current limit has been reached.

As shown by the vertical portions of the load line, when the unit is sinking power, the output voltage may continue to increase in the positive or negative direction as more current is forced into the unit. When the output voltage exceeds either the positive or negative over-voltage setting, the output will shut down, the output relays will open, and either the OV or OV- and the PROT status bits will be set. Either the user-defined over-voltage setting or the local over-voltage protection function can trip the over-voltage protection.

Current Priority Mode

In current priority mode, the output current should be programmed to the desired positive or negative value. A positive voltage limit value should also be set. The voltage limit should always be set higher than the actual output voltage requirement of the external load. With tracking enabled, the negative voltage limit tracks the positive voltage limit setting. With tracking disabled, you can set different values for the positive and negative voltage limits.

The following figure shows the current priority operating locus of the power modules. The area in the white quadrants shows the output as a source (sourcing power). The area in the shaded quadrants shows the output as a load (sinking power).

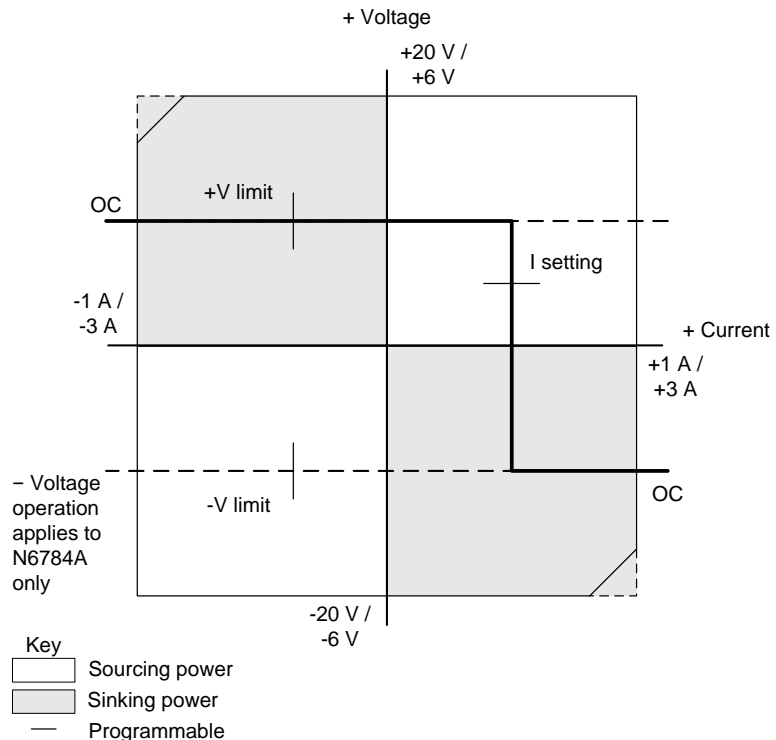

The heavy solid line illustrates the locus of possible operating points as a function of the output load. As shown by the vertical portion of the line, the output current remains regulated at its programmed setting as long as the output voltage remains within the positive or negative voltage limit setting. A CC (constant current) status flag indicates when the output voltage is within the limit settings.

If the output voltage reaches either the positive or negative voltage limit, the unit no longer operates in constant current mode and the output current is no longer held constant. Instead, the power supply will now regulate the output voltage at its voltage limit setting. Either a LIM+ (positive voltage limit) or LIM- (negative voltage limit) status flag is set to indicate that either the positive or negative voltage limit has been reached.

As shown by the horizontal portions of the load line, when the unit is sinking power, the output current may continue to increase in the positive or negative direction as more current is forced into the unit. Once the current exceeds 12% of the rated current of the range (1.12 A on the 1 A range; 3.36 A on the 3 A range), the output will shut down, the output relays will open, and the OC and PROT status bits will be set.

Index

A		D	
Admin menu, password	59	damage	25
airflow.....	26, 29, 102	data socket.....	58
All	64	DCL	58
allocation, power	110	Declaration of conformity.....	2
autoranging.....	121	default gateway.....	55
auxiliary voltage measurement.....	44	digital I/O	
auxiliary voltage measurements.....	78	configuring.....	105
		connections.....	105
B		digital input	
bandwidth	66	configuring.....	106
bench location.....	29	connections.....	106
		digitizer, programming	79
C		dimensions.....	102
capacitor, external.....	42	downprogramming.....	121
Caution	3		
CC	13	E	
channel		environmental conditions.....	26
groups	39, 95	Err	12, 49
location	26	external data logging	90
numbering	26	initiate	92
select.....	46, 62	returning arrays	93
cleaning.....	26	sample interval	91
connections		terminate.....	93
guard	34	trigger source.....	92
multiple load	35	external trigger	
negative voltage.....	42	configuring.....	106
parallel	38	connections.....	106
positive voltage	42		
remote sensing.....	36	F	
series.....	40	fault output	
contrast, front panel	97	configuring.....	107
control port, connector.....	104	connections.....	107
control socket	58	ferrite core.....	30
CP-.....	13	fetch commands	77
CP+.....	13, 110	frequency, 400 Hz	29
current		front panel	
measurement range	77	contrast.....	97
priority mode.....	63	display	12
returning current data.....	82	keys.....	13
setting	47, 63	lockout.....	96
current priority	123	menus.....	14
current sinking	121	screen saver.....	97
CV	13	view	97

Appendix E Source Operating Modes

front panel menu	
exiting	49
using	48

G

GPIB interface	50
address	50
ground	
earth	26
redundant	29
groups	
channel	95
view	12
guard connections	34

H

Hanning	81
Help	48, 49
history	2

I

INH	13
inhibit input	
configuring	107
connections	107
inspection	25
installation	26
instrument	
identification	94
storing states	94
IO	12, 50
IP address	54
items supplied	25

L

LAN interface	12, 51, 52, 53
parameters	54
private	52
site	52
sockets	58
Telnet	58
list	
arbitrary	75
programming	72
load connections	31
lockout, front panel	96

M

measure commands	77
measurement	
seamless autoranging	80, 91
measurement features	9
measurement trigger	
generate	85
initiate	84
source	83
measurements	
arrays	82
converter	83
Hanning window	81
Rectangular window	81
sample interval	80
simultaneous V and I	78
Menu	48
model differences	10
model numbers	24
multiple load connections	35

N

N6781A	
auxiliary measurements	78
resistance programming	66
N678xA	
digitizing speed	80
wire length requirements	33
non-volatile RAM settings	59

O

OC	13
OFF	13
options	24
oscillation protection	89
OT	13
outline diagram	26, 102
output	
bandwidth	66
enable	47, 64, 65
features	8
groups	39, 95
noise	37
polarity reversal	65
pulse	73
quadrant	122
resistance	66

state	108	reset states	22
step	68	resistance	66
turn-off	67		
turn-on delay	65	S	
output trigger		safety	3
enable	68	class	26
generate	70	warning	26
initiate	69	sample interval	80, 91
level	68	SCPI	
source	69	common commands	21
outputs in parallel	39	subsystem commands	16
outputs in series	41	screen saver	97
OV	13	self-test	94
over-current protection	87	sense leads, open	37
over-voltage protection	37, 86	sensitive loads	42
local	37	sockets	58
setting	48	specifications	
tracking	86	characteristics	99
		SRQ	58
P		step programming	68
parallel outputs	95	storing states	94
password	59	subnet mask	54, 55
front panel	96	support rails	28
PF	13	switching transients	42
power allocation	110	synchronizing measurements	83
power cord, connecting	30	system features	9
power factor 400 Hz	29	system protection	
power receptacle	26	clearing	108
pre-trigger data	81	connections	108
print date	2		
priority mode	122	T	
PROT	13	Telnet	58
protection		test extensions	72, 79
clearing	89	transient trigger	71
coupling	88	turn-off state	67
functions	86	turn-on delay	65
watchdog timer	88		
pulse	73	U	
		ungroup	95
R		UNR	13
rack mounting	28	updates	6
tools required	28	USB interface	51
Rectangular	81		
relay, output	65	V	
remote interface		voltage	
factory settings	59	measurement range	77
securing	59	priority mode	63
remote sensing	36		

Appendix E Source Operating Modes

returning voltage data.....	82
setting	46, 62
slew rate.....	64
voltage priority	122

W

Warning	3
watchdog timer	88
Web server.....	57
Web URL's	4
wire sizes	32